

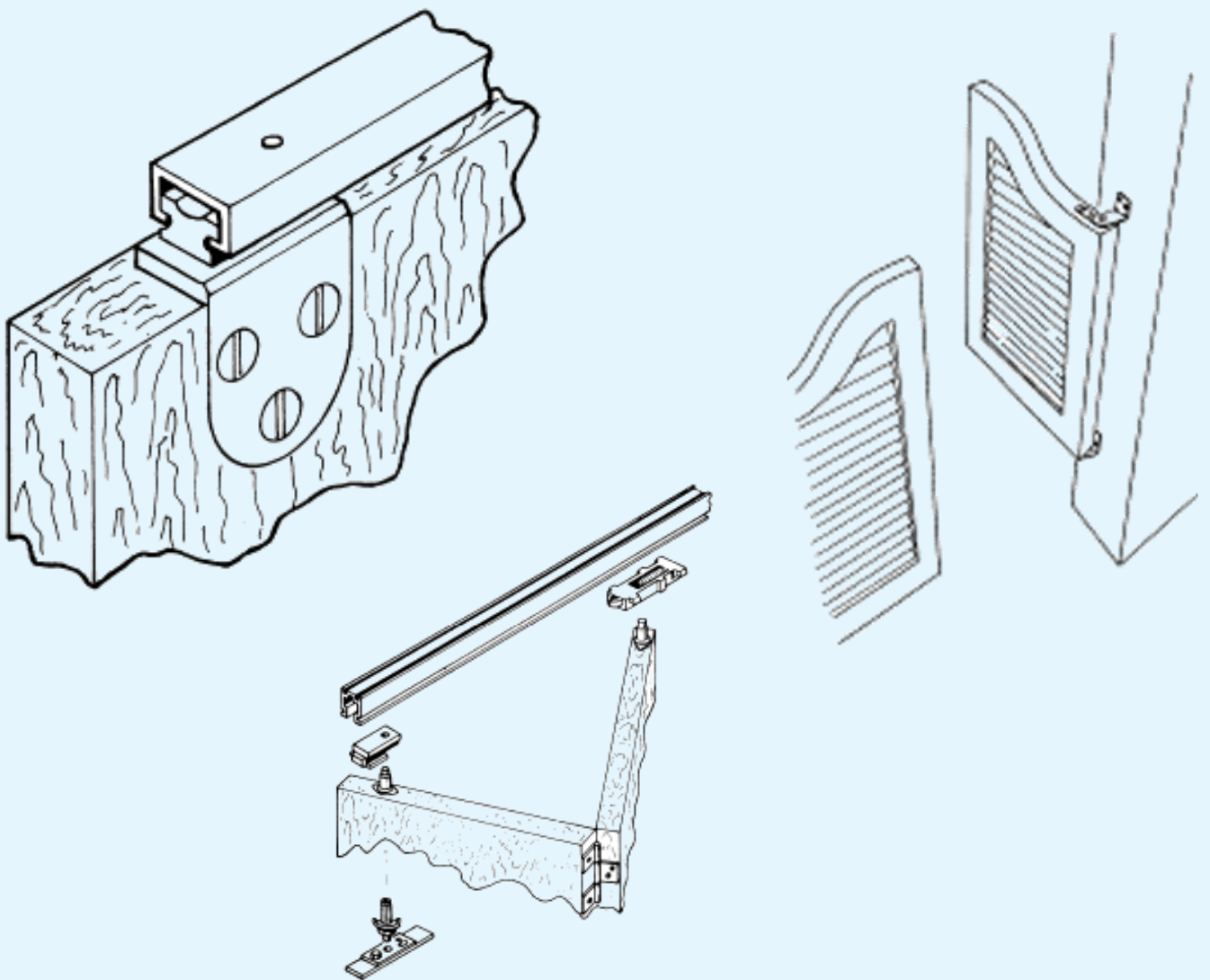

Beschläge für Schiebe- Falt- und Pendeltüren



Bauer Systemtechnik GmbH

Gewerbering 17, 84072 Au/Hallertau

Tel.: +49 (0) 8752-865809-0, Fax: +49 (0) 8752-9599

info@bauer-tore.de

Lieferzeit bei unseren Spezialkatalogen bitte anfragen!

Schrank-Schiebetürbeschlag bis 6 kg

Sliding door hardware for cupboards up to 6 kg

Ferrures à coulisse pour placards, poids de porte 6 kg

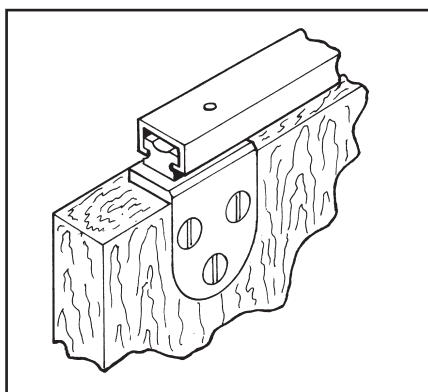

- **Türgewicht bis 6 kg**
- **Schienenlänge 1,0 m und 1,5 m**
- **der ideale Beschlag für Anrichten, Aufsatz- und Spülenunterschranke, Durchreichen, Wohnwagenschränke u.v.m.**
- **einfach zu montieren und problemlos ein- und auszuhängen**
- **wartungsfreie Aluminium-Laufschiene**
- **umfassende Beratung bis zur Endmontage durch verständliche Montageanleitungen in Wort und Bild**
- **komplett incl. Befestigungsmaterial und Montageanleitung in Kunststoffhülle eingeschumpft**
- **door weight up to 6 kg**
- **length of track 1,0 m and 1,5 m**
- **the ideal hardware for cupboards, under-sink cabinets, pass-throughs, motor home cabinets and many other applications**
- **easy installation, problem-free hanging and removal**
- **clear mounting-instructions with text and illustration offer complete consulting until final assembly**
- **complete sets incl. fixing screws and mounting instruction shrink packed**
- **poids de porte 6 kg**
- **longueur du rail 1,0 m et 1,5 m**
- **la ferrure idéale pour sous-évier, buffet-blocs, passe-plats, ameublement de caravanes etc.**
- **grande facilité de montage et démontage**
- **rail en aluminium, sans entretien**
- **des instructions de montage complètes (texte et illustrations) sont conçues pour une information détaillée jusqu'à la pose finale**
- **garnitures complètes avec visserie et instruction de montage sous sachet sous vide**

Türbeschläge sind auf das Gewicht der Türblätter abgestimmt. Bitte entnehmen Sie unserer Tabelle das Gewicht Ihrer gewählten Türblätter aus Spanplatten, Sperrholzplatten und Tischlerplatten und wählen Sie danach den richtigen Beschlag - HBS hat ihn in seinem bewährten Sortiment.

Door fittings vary according to door weight. Find the weight of your chip board, plywood or laminboard doors in the chart and choose the appropriate hardware. The HBS range meets your requirements.

Les ferrures sont conçues pour des poids différents de panneaux. Déterminez le poids de vos panneaux contreplaqués, lattés etc. du tableau et choisissez la ferrure appropriée. Vous en trouverez dans la gamme éprouvée HBS.

↓	Plattenstärke in mm Thickness of panel in mm Épaisseur du panneau en mm		Max. Plattengewicht in kg für 1 qm max. weight of panel in kg per square metre Poids maxi du panneau en kg par mètre carré	
	Spanplatte Chip board Panneau de particules	Sperrholzplatte, Bau-Furnierplatte Plywood, veneer boards Panneau de contreplaqué, bois de placage	Stäbchenverleimte Tischlerplatte Laminboard Panneau latté	
10	7,50	8,00		
12		9,60		
13	9,75		9,75	
14	10,50			
15		12,00		
16	12,00		12,00	
18	13,50	14,40		
19	14,25		14,25	
20		16,00		
22	16,50	17,60	16,50	
25	18,75	20,00	18,75	
28	21,00			
30		24,00	22,50	
35		28,00		
38			28,50	
40		32,00		
42			31,50	

Komplett-Bausätze und Zusatzsortimente

Der ideale Beschlag für Anrichten, Aufsatz- und Spülen-Unterschränke, Durchreichen, Wohnwagen-Schränke u.v.m.

HBS-Komplett-Bausatz Schränk-Schiebetür-Beschlag für 2 Schiebetüren

Schienenlänge 1,0 m;
Türgewicht bis 6 kg.

Komplett incl. Befestigungs-
material und Montage-
anleitung in Kunststoffhülle
eingeschrumpft.

HBS complete set Sliding door hardware for cupboards for 2 sliding-doors

Length of track 1,0 m;
Door weight up to 6 kg.

Complete sets incl. fixing
screws and mounting
instruction shrink packed

HBS jeu complet Ferrures à coulisse pour placards 2 portes à coulisse

Longueur du rail 1,0 m;
Poids de porte 6 kg maxi.

Garniture complète avec
visserie et instruction de
montage sous sachet sous
vide.

HBS-Komplett-Bausatz Schränk-Schiebetür-Beschlag für 2 Schiebetüren

Schienenlänge 1,5 m;
Türgewicht bis 6 kg.

Komplett incl. Befestigungs-
material und Montage-
anleitung in Kunststoffhülle
eingeschrumpft.

HBS complete set Sliding door hardware for cupboards for 2 sliding-doors

Length of track 1,5 m;
Door weight up to 6 kg.

Complete sets incl. fixing
screws and mounting
instruction shrink packed

HBS jeu complet Ferrures à coulisse pour placards 2 portes à coulisse

Longueur du rail 1,5 m;
Poids de porte 6 kg maxi.

Garniture complète avec
visserie et instruction de
montage sous sachet sous
vide.

HBS-Zusatzsortiment 1 Aluminium-Laufschiene

Länge 1,5 m

HBS extra set 1 aluminium track

length 1,5 m

HBS jeu complémentaire: 1 rail aluminium

longueur 1,5 m

HBS-Zusatzsortiment 1 Aluminium-Laufschiene

Länge 2,0 m

HBS extra set 1 aluminium track

length 2,0 m

HBS jeu complémentaire: 1 rail aluminium

longueur 2,0 m

HBS-Zusatzsortiment 2 Gleiter und 1 Bodenführung für 1 zusätzliche Tür

Türgewicht bis 6 kg.

HBS extra set containing: 2 gliders and 1 bottom guide for 1 additional door

Door weight up to 6 kg.

HBS jeu complémen- taire: 2 platins et 1 guide du bas pour 1 porte additionelle

Poids de porte 6 kg maxi.



HBS-Zusatzsortiment 2 Boden- führungen für 1 zusätzliche Tür

mit 4 mm breiter Führungsnut (unten)
oder Führung außen am Türblatt
ohne Führungsnut.
Incl. Befestigungsmaterial.

HBS extra set containing: 2 bottom guides for 1 additional door

With 4 mm wide bottom guide groove
or guiding outside without grooving.
Incl. fixing screws.

HBS jeu complémentaire: 2 guides du bas pour 1 porte additionelle

Avec rainure de guidage de
4 mm d'épaisseur (en bas)
ou guidage sans rainure à
l'extérieur du vantail.
Garniture complète.



HBS-Zusatzsortiment 3 Schienen-Türstopper

Türgewicht bis 6 kg.

HBS extra set containing: 3 track door stops

Door weight up to 6 kg.





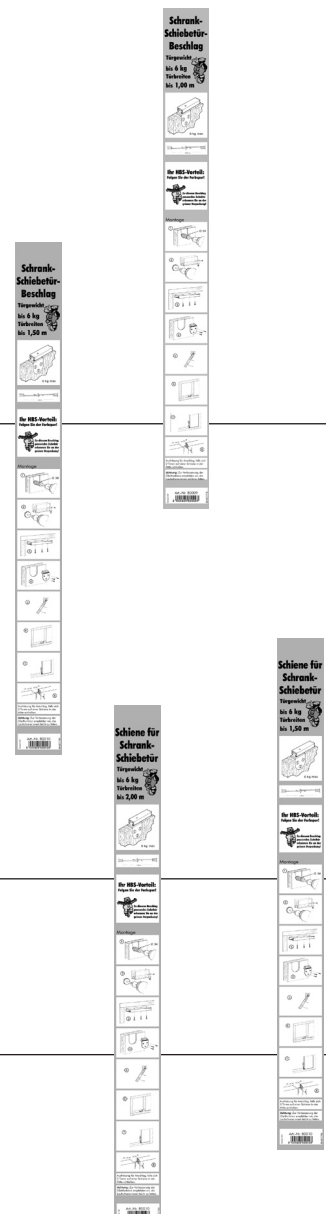
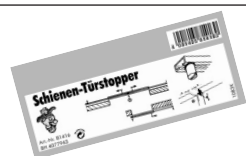









HBS jeu complémentaire: 3 butoirs de rail

Poids de porte 6 kg maxi.



Complete sets and extra sets, the ideal hardware for cupboards, under-sink cabinets, pass-throughs, motor home cabinets and many other applications

Jeux complets et jeux complémentaires, la ferrure idéale pour sours-éviers, buffet-blocs, passe-plats, ameublement de caravanes etc.

		Inhalt Part Contenu	Stück No. incl. Qté.	Art.-Nr. Art.-No. Art.-No.	Beschreibung Description Description								
<table border="1"> <tr> <td>Art.-Nr. Art.-No. Art.-No.</td> <td>80009</td> </tr> <tr> <td>EAN-Nr.</td> <td>4 001425 800097</td> </tr> <tr> <td>Gewicht/Garnitur Weight Poids</td> <td>0,37 kg</td> </tr> </table>		Art.-Nr. Art.-No. Art.-No.	80009	EAN-Nr.	4 001425 800097	Gewicht/Garnitur Weight Poids	0,37 kg	   	2 4 3 2	82037 81030 81199 81200	Alu-Laufschienen Länge 1,0 m Gleiter Bodenführungen Muschelgriffe	Aluminium tracks length 1,0 m Sliders Bottom guides Flush pulls	Rails aluminium longueur 1,0 m Patins Guides du bas Poignées "Cuvette"
Art.-Nr. Art.-No. Art.-No.	80009												
EAN-Nr.	4 001425 800097												
Gewicht/Garnitur Weight Poids	0,37 kg												
<table border="1"> <tr> <td>Art.-Nr. Art.-No. Art.-No.</td> <td>80010</td> </tr> <tr> <td>EAN-Nr.</td> <td>4 001425 800103</td> </tr> <tr> <td>Gewicht/Garnitur Weight Poids</td> <td>0,52 kg</td> </tr> </table>		Art.-Nr. Art.-No. Art.-No.	80010	EAN-Nr.	4 001425 800103	Gewicht/Garnitur Weight Poids	0,52 kg	   	2 4 3 2	82037 81030 81199 81200	Alu-Laufschiene Länge 1,50 m Gleiter Bodenführungen Muschelgriffe	Aluminium track length 1,50 m Sliders Bottom guides Flush pulls	Rail aluminium longueur 1,50 m Patins Guides du bas Poignées "Cuvette"
Art.-Nr. Art.-No. Art.-No.	80010												
EAN-Nr.	4 001425 800103												
Gewicht/Garnitur Weight Poids	0,52 kg												
<table border="1"> <tr> <td>Art.-Nr. Art.-No. Art.-No.</td> <td>82035</td> </tr> <tr> <td>EAN-Nr.</td> <td>4 001425 820354</td> </tr> <tr> <td>Gewicht/Garnitur Weight Poids</td> <td>0,20 kg</td> </tr> </table>		Art.-Nr. Art.-No. Art.-No.	82035	EAN-Nr.	4 001425 820354	Gewicht/Garnitur Weight Poids	0,20 kg		1	82035	Alu Laufschiene Länge 1,5 m	Aluminium track length 1,5 m	Rail aluminium longueur 1,5 m
Art.-Nr. Art.-No. Art.-No.	82035												
EAN-Nr.	4 001425 820354												
Gewicht/Garnitur Weight Poids	0,20 kg												
<table border="1"> <tr> <td>Art.-Nr. Art.-No. Art.-No.</td> <td>82036</td> </tr> <tr> <td>EAN-Nr.</td> <td>4 001425 820361</td> </tr> <tr> <td>Gewicht/Garnitur Weight Poids</td> <td>0,26 kg</td> </tr> </table>		Art.-Nr. Art.-No. Art.-No.	82036	EAN-Nr.	4 001425 820361	Gewicht/Garnitur Weight Poids	0,26 kg		1	82035	Alu Laufschiene Länge 2,0 m	Aluminium track length 2,0 m	Rail aluminium longueur 2,0 m
Art.-Nr. Art.-No. Art.-No.	82036												
EAN-Nr.	4 001425 820361												
Gewicht/Garnitur Weight Poids	0,26 kg												
<table border="1"> <tr> <td>Art.-Nr. Art.-No. Art.-No.</td> <td>80032</td> </tr> <tr> <td>EAN-Nr.</td> <td>4 001425 800325</td> </tr> <tr> <td>Gewicht/Garnitur Weight Poids</td> <td>0,04 kg</td> </tr> </table>		Art.-Nr. Art.-No. Art.-No.	80032	EAN-Nr.	4 001425 800325	Gewicht/Garnitur Weight Poids	0,04 kg	  	2 1 1	81030 81199 81200	Gleiter Bodenführung Muschelgriff	Sliders Bottom guide Flush pull	Patins Guide du bas Poignée "Cuvette"
Art.-Nr. Art.-No. Art.-No.	80032												
EAN-Nr.	4 001425 800325												
Gewicht/Garnitur Weight Poids	0,04 kg												
<table border="1"> <tr> <td>Art.-Nr. Art.-No. Art.-No.</td> <td>81419</td> </tr> <tr> <td>EAN-Nr.</td> <td>4 001425 814193</td> </tr> <tr> <td>Gewicht/Garnitur Weight Poids</td> <td>0,01 kg</td> </tr> </table>		Art.-Nr. Art.-No. Art.-No.	81419	EAN-Nr.	4 001425 814193	Gewicht/Garnitur Weight Poids	0,01 kg		2	81419	Bodenführung zum Anschrauben; Führungsnut 4 mm breit	Bottom guide for screw mounting; bottom guide groove 4 mm wide	Guide du bas à visser; rainure de guidage de 4 mm d'épaisseur
Art.-Nr. Art.-No. Art.-No.	81419												
EAN-Nr.	4 001425 814193												
Gewicht/Garnitur Weight Poids	0,01 kg												
<table border="1"> <tr> <td>Art.-Nr. Art.-No. Art.-No.</td> <td>81416</td> </tr> <tr> <td>EAN-Nr.</td> <td>4 001425 814162</td> </tr> <tr> <td>Gewicht/Garnitur Weight Poids</td> <td>0,05 kg</td> </tr> </table>		Art.-Nr. Art.-No. Art.-No.	81416	EAN-Nr.	4 001425 814162	Gewicht/Garnitur Weight Poids	0,05 kg		3	81153	Schienen-Türstopper	Track door stops	Butoirs de rail
Art.-Nr. Art.-No. Art.-No.	81416												
EAN-Nr.	4 001425 814162												
Gewicht/Garnitur Weight Poids	0,05 kg												

Schrank-Schiebetürbeschlag bis 28 kg + bis 38 kg

Sliding door hardware up to 28 kg + up to 38 kg

Ferrures pour portes coulissantes 28 kg maxi + 38 kg

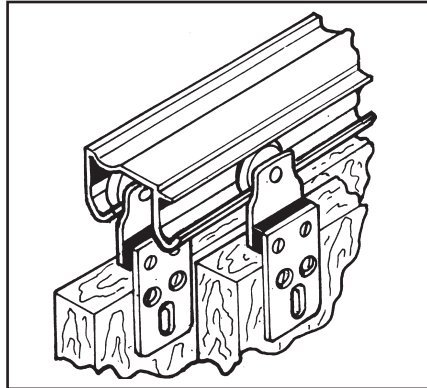

- **Türgewicht bis 28 kg und 38 kg**
- **Schienenlänge 1,5 m und 2,0 m**
- **der ideale Beschlag für Garderoben, Schrank- sowie leichte Innentüren, Holztafelungen u.v.m.**
- **bewährte und solide Konstruktionen**
- **saubere Verarbeitung und Wartungsfreiheit**
- **individuelle Gestaltungsmöglichkeiten durch die freie Wahl der Türblattgrößen und des Materials**
- **umfassende Beratung bis zur Endmontage durch verständliche Montageanleitungen in Wort und Bild**
- **komplett incl. Befestigungsmaterial und Montageanleitung in Kunststoffhülle eingeschumpft**

- **door weight up to 28 kg and 38 kg**
- **length of track 1,5 m and 2,0 m**
- **the ideal hardware for cupboards, under-sink cabinets, pass-throughs, motor home cabinets and many other applications**
- **proven and solid construction**
- **carefully manufactured and maintenance-free**
- **individual configuration possible due to choice of panel size and material**
- **clear mounting-instructions with text and illustration offer complete consulting until final assembly**
- **complete sets incl. fixing screws and mounting instruction shrink packed**
- **poids de porte 28 kg maxi et 38 kg**
- **longueur du rail 1,5 m et 2,0 m**
- **la ferrure idéale pour garde-robes, placards, portes intérieures légères, panneaux de boiserie etc.**
- **construction éprouvée et robuste**
- **fabrication soignée et ne nécessitant pas d'entretien**
- **aménagement individuel par le choix des grandeurs, des panneaux et du matériau**
- **des instructions de montage complètes (texte et illustrations) sont conçues pour une information détaillée jusqu'à la pose finale**
- **garnitures complètes avec visserie et instruction de montage sous sachet sous vide**

Türbeschläge sind auf das Gewicht der Türblätter abgestimmt. Bitte entnehmen Sie unserer Tabelle das Gewicht Ihrer gewählten Türblätter aus Spanplatten, Sperrholzplatten und Tischlerplatten und wählen Sie danach den richtigen Beschlag - HBS hat ihn in seinem bewährten Sortiment.

Door fittings vary according to door weight. Find the weight of your chip board, plywood or laminboard doors in the chart and choose the appropriate hardware. The HBS range meets your requirements.

Les ferrures sont conçues pour des poids différents de panneaux. Déterminez le poids de vos panneaux contreplaqués, lattés etc. du tableau et choisissez la ferrure appropriée. Vous en trouverez dans la gamme éprouvée HBS.

↓ Plattenstärke in mm Thickness of panel in mm Épaisseur du panneau en mm	Max. Plattengewicht in kg für 1 qm max. weight of panel in kg per square metre Poids maxi du panneau en kg par mètre carré		
	Spanplatte Chip board Panneau de particules	Sperrholzplatte, Bau-Furnierplatte Plywood, veneer boards Panneau de contreplaqué, bois de placage	Stäbchenverleimte Tischlerplatte Laminboard Panneau latté
10	7,50	8,00	
12		9,60	
13	9,75		9,75
14	10,50		
15		12,00	
16	12,00		12,00
18	13,50	14,40	
19	14,25		14,25
20		16,00	
22	16,50	17,60	16,50
25	18,75	20,00	18,75
28	21,00		
30		24,00	22,50
35		28,00	
38			28,50
40		32,00	
42			31,50

Komplett-Bausätze und Zusatzsortimente

Der ideale Beschlag für Garderoben, Schrank- und leichte Innentüren

HBS-Komplett-Bausatz Schrank-Schiebetür-Beschlag für 2 Schiebetüren

Schienenlänge 1,5 m; Türgewicht bis 28 kg und 38 kg; für Türstärken von 19-40 mm und 4 mm breite Führungsnut (unten).
Komplett incl. Befestigungsmaterial und Montageanleitung in Kunststoffhülle eingeschumpft.

HBS complete set Sliding door hardware for 2 sliding-doors

Length of track 1,5 m; door weight up to 28 kg and 38 kg; door thickness 19-40 mm and 4 mm wide bottom guide groove.
Complete with fixing screws and mounting instruction shrink packed

HBS jeu complet Ferrures pour portes coulissantes 2 portes à coulisse

Longueur du rail 1,5 m; poids de porte 28 kg et 38 kg maxi; épaisseur de porte de 19 à 40 mm et rainure de guidage de 4mm d'épaisseur (en bas).
Jeu complet avec vis de pose et instruction de montage sous sachet sous vide.



HBS-Komplett-Bausatz Schrank-Schiebetür-Beschlag für 2 Schiebetüren

Schienenlänge 2 m; Türgewicht bis 28 kg und 38 kg; für Türstärken von 19-40 mm und 4 mm breite Führungsnut (unten).
Komplett incl. Befestigungsmaterial und Montageanleitung in Kunststoffhülle eingeschumpft.

HBS complete set Sliding door hardware for 2 sliding-doors

Length of track 2 m; door weight up to 28 kg and 38 kg; door thickness 19-40 mm and 4 mm wide bottom guide groove.
Complete with fixing screws and mounting instruction shrink packed

HBS jeu complet Ferrures pour portes coulissantes 2 portes à coulisse

Longueur du rail 2 m; poids de porte 28 kg et 38 kg maxi; épaisseur de porte de 19 à 40 mm et rainure de guidage de 4mm d'épaisseur (en bas).
Jeu complet avec vis de pose et instruction de montage sous sachet sous vide.



HBS-Zusatzsortiment 1 Aluminium-Doppel-Laufschiene

Länge 2,0 m
Türgewicht bis 38 kg.

HBS extra set 1 aluminium double track

length 2,0 m
Door weight up to 38 kg.

HBS jeu complémentaire: 1 rail aluminium double

longueur 2,0 m
Poids de porte 38 kg maxi.



HBS-Zusatzsortiment 1 Aluminium-Laufschiene

Länge 2,0 m
Türgewicht bis 38 kg.

HBS extra set 1 aluminium track











length 2,0 m
Door weight up to 38 kg.

HBS jeu complémentaire: 1 rail aluminium

longueur 2,0 m
Poids de porte 38 kg maxi.



**Complete sets and extra sets,
the ideal hardware for wardrobes, cupboards, and light interior doors**
**Jeux complets et jeux complémentaires,
idéal pour gare-robes, placards et portes intérieures légères**

		Inhalt Part Contenu	Stück No. incl. Qté.	Art.-Nr. Art.-No. Art.-No.	Beschreibung Description Description								
<table border="1"> <tr> <td>Art.-Nr. Art.-No. Art.-No.</td> <td>80012</td> </tr> <tr> <td>EAN-Nr.</td> <td>4001425 800127</td> </tr> <tr> <td>Gewicht/Garnitur Weight Poids</td> <td>1,16 kg</td> </tr> </table>		Art.-Nr. Art.-No. Art.-No.	80012	EAN-Nr.	4001425 800127	Gewicht/Garnitur Weight Poids	1,16 kg	   	1	82018	Alu-Doppel-Laufschiene,- Länge 1,5 m	Aluminium double track, length 1,5 m	Rail alu double, longeur 1,5 m
Art.-Nr. Art.-No. Art.-No.	80012												
EAN-Nr.	4001425 800127												
Gewicht/Garnitur Weight Poids	1,16 kg												
			4	81011	Einzel-Rollapparate mit Walzenlager	One-wheel-hangers with roller bearing	Montures à 1 galet avec roulement à rouleaux						
			2	81199	Bodenführungen	Bottom guides	Guides du bas						
			1	81200	Muschelgriff	Flush pull	Poignée "Cuvette"						
<table border="1"> <tr> <td>Art.-Nr. Art.-No. Art.-No.</td> <td>80013</td> </tr> <tr> <td>EAN-Nr.</td> <td>4001425 800134</td> </tr> <tr> <td>Gewicht/Garnitur Weight Poids</td> <td>1,39 kg</td> </tr> </table>		Art.-Nr. Art.-No. Art.-No.	80013	EAN-Nr.	4001425 800134	Gewicht/Garnitur Weight Poids	1,39 kg	   	1	82019	Alu-Doppel-Laufschiene,- Länge 2 m	Aluminium double track, length 2 m	Rail aluminium double, longeur 2 m
Art.-Nr. Art.-No. Art.-No.	80013												
EAN-Nr.	4001425 800134												
Gewicht/Garnitur Weight Poids	1,39 kg												
			4	81011	Einzel-Rollapparate mit Walzenlager	One-wheel-hangers with roller bearing	Montures à 1 galet avec roulement à rouleaux						
			2	81199	Bodenführungen	Bottom guides	Guides du bas						
			1	81200	Muschelgriff	Flush pull	Poignée "Cuvette"						
<table border="1"> <tr> <td>Art.-Nr. Art.-No. Art.-No.</td> <td>82027</td> </tr> <tr> <td>EAN-Nr.</td> <td>4001425 820279</td> </tr> <tr> <td>Gewicht/Garnitur Weight Poids</td> <td>1,51 kg</td> </tr> </table>		Art.-Nr. Art.-No. Art.-No.	82027	EAN-Nr.	4001425 820279	Gewicht/Garnitur Weight Poids	1,51 kg		1	82027	Alu-Doppel-Laufschiene Länge 2,0 m	Aluminium double track length 2,0 m	Rail aluminium double longueur 2,0 m
Art.-Nr. Art.-No. Art.-No.	82027												
EAN-Nr.	4001425 820279												
Gewicht/Garnitur Weight Poids	1,51 kg												
<table border="1"> <tr> <td>Art.-Nr. Art.-No. Art.-No.</td> <td>82010</td> </tr> <tr> <td>EAN-Nr.</td> <td>4001425 820101</td> </tr> <tr> <td>Gewicht/Garnitur Weight Poids</td> <td>0,82 kg</td> </tr> </table>		Art.-Nr. Art.-No. Art.-No.	82010	EAN-Nr.	4001425 820101	Gewicht/Garnitur Weight Poids	0,82 kg		1	82010	Alu-Laufschiene Länge 2,0 m	Aluminium track length 2,0 m	Rail aluminium longueur 2,0 m
Art.-Nr. Art.-No. Art.-No.	82010												
EAN-Nr.	4001425 820101												
Gewicht/Garnitur Weight Poids	0,82 kg												

Komplett-Bausätze und Zusatzsortimente

Der ideale Beschlag für Garderoben, Schrank- und leichte Innentüren

HBS-Zusatzsortiment 2 Einzel-Rollapparate und 1 Bodenführung für 1 zusätzliche Tür

Türgewicht bis 28 kg.

Incl. Befestigungsmaterial.

HBS extra set
containing:
2 one-wheel hangers
and 1 bottom guide for
1 additional door

Door weight up to 28 kg.

Incl. fixing screws.

**HBS jeu complémen-
taire:**
2 montures à galet
et 1 guide du bas pour
1 porte additionelle

Poids de porte 28 kg maxi.

Avec vis de pose.



HBS-Zusatzsortiment 2 Doppel-Rollapparate und 1 Bodenführung für 1 Tür

Türgewicht bis 38 kg.

Incl. Befestigungsmaterial.

HBS extra set
containing:
2 two-wheel hangers
and 1 bottom guide for
1 door

Door weight up to 38 kg.

Incl. fixing screws.

**HBS jeu complémen-
taire:**
2 montures à 2 galets
et 1 guide du bas pour
1 porte

Poids de porte 38 kg maxi.

Avec vis de pose.



HBS-Zusatzsortiment 81419 2 Bodenführungen für 1 zusätzliche Tür

mit 4 mm breiter Führungsnut
(unten) oder Führung außen am
Türblatt ohne Führungsnut.

Incl. Befestigungsmaterial.

HBS extra set 81419
containing:
2 bottom guides for
1 additional door

With 4 mm wide bottom guide groove
or guiding outside without grooving.

Incl. fixing screws.

HBS jeu complémentaire 81419:
2 guides du bas pour
1 porte additionelle

Avec rainure de guidage de
4 mm d'épaisseur (en bas) ou
guidage sans rainure à l'extérieur
du vantail.

Garniture complète.



HBS-Zusatzsortiment 81418 2 Bodenführungen für 1 zusätzliche Tür

Mit 5 mm breiter Führungsnut
(unten) oder Führung außen
am Türblatt ohne Führungsnut.

Komplett incl. Befestigungs-
material.

HBS extra set 81418
containing:
2 bottom guides for
1 additional door

With 5 mm wide bottom
guide groove or guiding
on door outside without
grooving.

Complete incl. fixing screws.

**HBS jeu complémen-
taire 81418:**
2 guides du bas pour
1 porte additionelle

Avec rainure de guidage de
5 mm d'épaisseur (en bas)
ou guidage sans rainure à
l'extérieur du vantail.

Jeu complet avec vis de pose.



HBS-Zusatzsortiment 2 Türstopper zum Anschrauben an Wand oder Türe

Türgewicht bis 38 kg.

Incl. Befestigungsmaterial.

HBS extra set
containing:
2 door stops for wall
or door fixing

Door weight up to 38 kg.

Incl. fixing screws.









**HBS jeu complémen-
taire:**
2 butées à visser au
mur ou à la porte

Poids de porte 38 kg maxi.

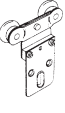
Avec vis de pose.



**Complete sets and extra sets,
the ideal hardware for wardrobes, cupboards, and light interior doors**
**Jeux complets et jeux complémentaires,
idéal pour gare-robes, placards et portes intérieures légères**

		Inhalt Part Contenu	Stück No. incl. Qté.	Art.-Nr. Art.-No. Art.-No.	Beschreibung Description Description								
<table border="1"> <tr> <td>Art.-Nr. Art.-No. Art.-No.</td> <td>81414</td> </tr> <tr> <td>EAN-Nr.</td> <td>4001425814148</td> </tr> <tr> <td>Gewicht/Garnitur Weight Poids</td> <td>0,17 kg</td> </tr> </table>		Art.-Nr. Art.-No. Art.-No.	81414	EAN-Nr.	4001425814148	Gewicht/Garnitur Weight Poids	0,17 kg	  	2 1 1	81011 81200 81199	Einzel-Rollapparate mit Walzenlager, verzinkt; max. Türgewicht = 28 kg Muschelgriff Bodenführung	One-wheel-hangers with roller bearing, galvanized; door weight up to 28 kg Flush pull Bottom guide	Montures à galet avec roulement à rouleaux, galvanisées; poids de porte 28 kg maxi Poignée "Cuvette" Guide du bas
Art.-Nr. Art.-No. Art.-No.	81414												
EAN-Nr.	4001425814148												
Gewicht/Garnitur Weight Poids	0,17 kg												
<table border="1"> <tr> <td>Art.-Nr. Art.-No. Art.-No.</td> <td>81415</td> </tr> <tr> <td>EAN-Nr.</td> <td>4001425814155</td> </tr> <tr> <td>Gewicht/Garnitur Weight Poids</td> <td></td> </tr> </table>		Art.-Nr. Art.-No. Art.-No.	81415	EAN-Nr.	4001425814155	Gewicht/Garnitur Weight Poids		  	2 1 1	81016 81200 81172	Doppel-Rollapparate mit Walzenlager, verzinkt; max. Türgewicht = 38 kg Muschelgriff Bodenführung	Two-wheel-hangers with roller bearing, galvanized; door weight up to 38 kg Flush pull Bottom guide	Montures à 2 galets avec roulement à rouleaux, galvanisées; poids de porte 38 kg maxi Poignée "Cuvette" Guide du bas
Art.-Nr. Art.-No. Art.-No.	81415												
EAN-Nr.	4001425814155												
Gewicht/Garnitur Weight Poids													
<table border="1"> <tr> <td>Art.-Nr. Art.-No. Art.-No.</td> <td>81419</td> </tr> <tr> <td>EAN-Nr.</td> <td>4001425814193</td> </tr> <tr> <td>Gewicht/Garnitur Weight Poids</td> <td>0,01 kg</td> </tr> </table>		Art.-Nr. Art.-No. Art.-No.	81419	EAN-Nr.	4001425814193	Gewicht/Garnitur Weight Poids	0,01 kg		2	81419	Bodenführung zum Anschrauben; Führungsnut 4 mm breit	Bottom guide for screw mounting; bottom guide groove 4 mm wide	Guide du bas à visser; rainure de guidage de 4 mm d'épaisseur
Art.-Nr. Art.-No. Art.-No.	81419												
EAN-Nr.	4001425814193												
Gewicht/Garnitur Weight Poids	0,01 kg												
<table border="1"> <tr> <td>Art.-Nr. Art.-No. Art.-No.</td> <td>81418</td> </tr> <tr> <td>EAN-Nr.</td> <td>4001425814186</td> </tr> <tr> <td>Gewicht/Garnitur Weight Poids</td> <td>0,02 kg</td> </tr> </table>		Art.-Nr. Art.-No. Art.-No.	81418	EAN-Nr.	4001425814186	Gewicht/Garnitur Weight Poids	0,02 kg		2	81172	Bodenführung zum Anschrauben; Führungsnut 5 mm breit, oder Bodenführung außen	Bottom guide for screw fixing; bottom guide groove 5 mm wide or bottom guiding on door outside	Guide du bas à visser; rainure de guidage de 5 mm d'épaisseur ou guidage du bas à l'extérieur du vantail
Art.-Nr. Art.-No. Art.-No.	81418												
EAN-Nr.	4001425814186												
Gewicht/Garnitur Weight Poids	0,02 kg												
<table border="1"> <tr> <td>Art.-Nr. Art.-No. Art.-No.</td> <td>81417</td> </tr> <tr> <td>EAN-Nr.</td> <td>4001425814179</td> </tr> <tr> <td>Gewicht/Garnitur Weight Poids</td> <td>0,05 kg</td> </tr> </table>		Art.-Nr. Art.-No. Art.-No.	81417	EAN-Nr.	4001425814179	Gewicht/Garnitur Weight Poids	0,05 kg		2	81154	Türstopper zum Anschrauben an Wand oder Tür	Door stops for wall or door fixing	Butées à visser au mur ou à la porte
Art.-Nr. Art.-No. Art.-No.	81417												
EAN-Nr.	4001425814179												
Gewicht/Garnitur Weight Poids	0,05 kg												

Zimmer-Schiebetürbeschlag bis 40 + 60 kg

Sliding door gears up to 40 + 60 kg

Ferrures de portes à coulisse 40 + 60 kg

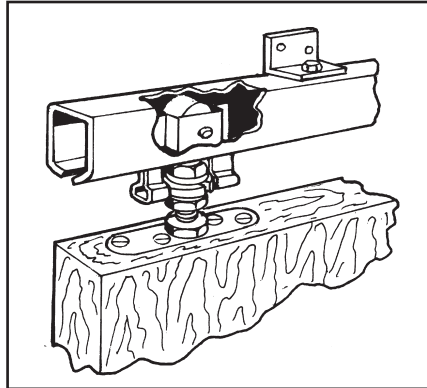

- Türgewicht bis 40 kg und bis 60 kg
- Schienenlänge 1,55 m und 1,85 m (40 kg)
- Schienenlänge 1,85 m und 2,30 m (60 kg)
- Beschlagteile und Laufschiene verzinkt
- auch für den Außenbereich bestens geeignet
- umfassende Beratung bis zur Endmontage durch verständliche Montageanleitungen in Wort und Bild
- komplett incl. Befestigungsmaterial und Montageanleitung in Kunststoffhülle eingeschumpft

- door weight up to 40 kg and 60 kg
- length of track 1,55 m and 1,85 m (40 kg)
- length of track 1,55 m and 2,30 m (60 kg)
- fittings and track galvanized
- also suitable for outdoor applications
- clear mounting-instructions with text and illustration offer complete consulting until final assembly
- poids de porte 40 kg et 60 kg
- longueur du rail 1,55 m et 1,85 m (40 kg)
- longueur du rail 1,85 m et 2,30 m (60 kg)
- pièces et rail galvanisés
- poses à l'extérieur possibles
- des instructions de montage complètes (texte et illustrations) sont conçues pour une information détaillée jusqu'à la pose finale
- garnitures complètes avec visserie et instruction de montage sous sachet sous vide

Türbeschläge sind auf das Gewicht der Türblätter abgestimmt. Bitte entnehmen Sie unserer Tabelle das Gewicht Ihrer gewählten Türblätter aus Spanplatten, Sperrholzplatten und Tischlerplatten und wählen Sie danach den richtigen Beschlag - HBS hat ihn in seinem bewährten Sortiment.

Door fittings vary according to door weight. Find the weight of your chip board, plywood or laminboard doors in the chart and choose the appropriate hardware. The HBS range meets your requirements.

Les ferrures sont conçues pour des poids différents de panneaux. Déterminez le poids de vos panneaux contreplaqués, lattés etc. du tableau et choisissez la ferrure appropriée. Vous en trouverez dans la gamme éprouvée HBS.

↓ Plattenstärke in mm Thickness of panel in mm Épaisseur du panneau en mm	Max. Plattengewicht in kg für 1 qm max. weight of panel in kg per square metre Poids maxi du panneau en kg par mètre carré		
	Spanplatte Chip board Panneau de particules	Sperrholzplatte, Bau-Furnierplatte Plywood, veneer boards Panneau de contreplaqué, bois de placage	Stäbchenverleimte Tischlerplatte Laminboard Panneau latté
10	7,50	8,00	
12		9,60	
13	9,75		9,75
14	10,50		
15		12,00	
16	12,00		12,00
18	13,50	14,40	
19	14,25		14,25
20		16,00	
22	16,50	17,60	16,50
25	18,75	20,00	18,75
28	21,00		
30		24,00	22,50
35		28,00	
38			28,50
40		32,00	
42			31,50

Komplett-Bausätze und Zusatzsortimente

Der ideale Beschlag für Zimmertüren bis 40 kg

HBS-Komplett-Bausatz 155 cm für 1 Schiebetür

Schienenlänge 1,55 m;
Türgewicht bis 40 kg.

Komplett incl. Befestigungs-
material und Montage-
anleitung in Kunststoffhülle
eingeschrumpft.

Montageanleitung siehe
Seite 10.03.10.

HBS complete set 155 cm for 1 sliding door

Length of track 1,55 m;
Door weight up to 40 kg.

Complete set incl. fixing
screws and mounting
instruction shrink packed

Mounting instruction see
page 10.03.10.

HBS jeu complet 155 cm 1 porte à coulisse

Longueur du rail 1,55 m;
Poids de porte 40 kg maxi.

Garniture complète avec
visserie et instruction de
montage sous sachet sous
vide.

Instruction de montage voir
page 10.03.10.



HBS-Komplett-Bausatz 185 cm für 1 Schiebetür

Schienenlänge 1,85 m;
Türgewicht bis 40 kg.

Komplett incl. Befestigungs-
material und Montage-
anleitung in Kunststoffhülle
eingeschrumpft.

Montageanleitung siehe
Seite 10.03.10.

HBS complete set 185 cm for 1 sliding door

Length of track 1,85 m;
Door weight up to 40 kg.

Complete set incl. fixing
screws and mounting
instruction shrink packed

Mounting instruction see
page 10.03.10.

HBS jeu complet 185 cm 1 porte à coulisse

Longueur du rail 1,85 m;
Poids de porte 40 kg maxi.

Garniture complète avec
visserie et instruction de
montage sous sachet sous
vide.

Instruction de montage voir
page 10.03.10.



HBS-Zusatzsortiment 1 Stahl-Laufschiene

Länge 1,85 m
Türgewicht bis 40 kg.

HBS extra set 1 steel track

















length 1,85 m
Door weight up to 40 kg.

HBS jeu complémentaire: 1 rail acier

longueur 1,85 m
Poids de porte 40 kg maxi.



**Complete sets and extra sets,
the ideal sliding door gear for interior doors up to 40 kg
Jeux complets et jeux complémentaires,
la ferrure idéale pour portes intérieures 40 kg**

		Inhalt Part Contenu	Stück No. incl. Qté.	Art.-Nr. Art.-No. Art.-No.	Beschreibung Description Description								
<table border="1"> <tr> <td>Art.-Nr. Art.-No. Art.-No.</td> <td>80003</td> </tr> <tr> <td>EAN-Nr.</td> <td>4001425800035</td> </tr> <tr> <td>Gewicht/Garnitur Weight Poids</td> <td>1,85 kg</td> </tr> </table>		Art.-Nr. Art.-No. Art.-No.	80003	EAN-Nr.	4001425800035	Gewicht/Garnitur Weight Poids	1,85 kg	       	<p>1</p> <p>2</p> <p>2</p> <p>2</p> <p>2</p> <p>1</p> <p>4</p> <p>1</p>	<p>82041</p> <p>81034</p> <p>81010</p> <p>81009</p> <p>81166</p> <p>81172</p> <p>81269</p>	<p>Stahl-Laufschiene sendz. verzinkt, 1,55 m</p> <p>Einzel-Rollapparate</p> <p>Anschraubplatten</p> <p>Anschraubplatten für Seitenbefestigung</p> <p>Schienen-Türstopper</p> <p>Bodenführung</p> <p>Wandbefestigungs- winkel</p> <p>Gabelschlüssel</p>	<p>Track, steel galvanized Sendzimir, 1,55 m</p> <p>Single hangers</p> <p>Fixing plates</p> <p>Side fixing plates</p> <p>Track door stops</p> <p>Bottom guide</p> <p>Side fixing brackets</p> <p>Wrench</p>	<p>Rail galvanisé, Sendzimir, 1,55 m</p> <p>Montures à galets simples</p> <p>Platines sur chant</p> <p>Platines sur plat</p> <p>Butées de rail</p> <p>Guide du bas</p> <p>Supports équerres</p> <p>Clé</p>
Art.-Nr. Art.-No. Art.-No.	80003												
EAN-Nr.	4001425800035												
Gewicht/Garnitur Weight Poids	1,85 kg												
<table border="1"> <tr> <td>Art.-Nr. Art.-No. Art.-No.</td> <td>80004</td> </tr> <tr> <td>EAN-Nr.</td> <td>4001425800042</td> </tr> <tr> <td>Gewicht/Garnitur Weight Poids</td> <td>2,16 kg</td> </tr> </table>		Art.-Nr. Art.-No. Art.-No.	80004	EAN-Nr.	4001425800042	Gewicht/Garnitur Weight Poids	2,16 kg	       	<p>1</p> <p>2</p> <p>2</p> <p>2</p> <p>2</p> <p>1</p> <p>5</p> <p>1</p>	<p>82042</p> <p>81034</p> <p>81010</p> <p>81009</p> <p>81166</p> <p>81172</p> <p>81269</p>	<p>Stahl-Laufschiene sendz. verzinkt, 1,85 m</p> <p>Einzel-Rollapparate</p> <p>Anschraubplatten</p> <p>Anschraubplatten für Seitenbefestigung</p> <p>Schienen-Türstopper</p> <p>Bodenführung</p> <p>Wandbefestigungs- winkel</p> <p>Gabelschlüssel</p>	<p>Track, steel galvanized Sendzimir, 1,85 m</p> <p>Single hangers</p> <p>Fixing plates</p> <p>Side fixing plates</p> <p>Track door stops</p> <p>Bottom guide</p> <p>Side fixing brackets</p> <p>Wrench</p>	<p>Rail galvanisé, Sendzimir, 1,85 m</p> <p>Montures à galets simples</p> <p>Platines sur chant</p> <p>Platines sur plat</p> <p>Butées de rail</p> <p>Guide du bas</p> <p>Supports équerres</p> <p>Clé</p>
Art.-Nr. Art.-No. Art.-No.	80004												
EAN-Nr.	4001425800042												
Gewicht/Garnitur Weight Poids	2,16 kg												
<table border="1"> <tr> <td>Art.-Nr. Art.-No. Art.-No.</td> <td>82042</td> </tr> <tr> <td>EAN-Nr.</td> <td>4001425820422</td> </tr> <tr> <td>Gewicht/Garnitur Weight Poids</td> <td>1,72 kg</td> </tr> </table>		Art.-Nr. Art.-No. Art.-No.	82042	EAN-Nr.	4001425820422	Gewicht/Garnitur Weight Poids	1,72 kg		<p>1</p>	<p>82042</p>	<p>Stahl-Laufschiene sendz. verzinkt Länge 1,85 m</p>	<p>Track, steel galvanized Sendzimir length 1,85 m</p>	<p>Rail galvanisé Sendzimir longueur 1,85 m</p>
Art.-Nr. Art.-No. Art.-No.	82042												
EAN-Nr.	4001425820422												
Gewicht/Garnitur Weight Poids	1,72 kg												

Komplett-Bausätze und Zusatzsortimente

Der ideale Beschlag für Zimmertüren bis 40 kg

HBS-Zusatzsortiment 80031 2 Einzel-Rollapparate für 1 zusätzliche Tür

Türgewicht bis 40 kg.

Komplett incl.
Befestigungsmaterial.

HBS extra set 80031
containing:
2 one-wheel hangers for
1 additional door

Door weight up to 40 kg.

Complete set
incl. fixing screws.

**HBS jeu complémen-
taire 80031:**
2 montures à galet pour
1 porte additionnelle

Poids de porte 40 kg maxi.

Garniture complète
avec visserie.



HBS-Zusatzsortiment 81418 Bodenführungen für 1 zusätzliche Tür

Mit 5 mm breiter Führungsnut
(unten) **oder** Führung außen
am Türblatt ohne Führungsnut.

Komplett incl. Befestigungs-
material.

HBS extra set 81418
containing:
bottom guides for
1 additional door

With 5 mm wide bottom
guide groove **or** guiding
on door outside without
grooving.

Complete set incl.
fixing screws.

**HBS jeu complémen-
taire 81418:**
guides du bas pour
1 porte additionnelle

Avec rainure de guidage de
5 mm d'épaisseur (en bas)
ou guidage sans rainure à
l'extérieur du vantail.

Garniture complète
avec visserie.



HBS-Zusatzsortiment Verbindungsuffe zum Verbinden zweier Laufschiene

Stahl, verzinkt.

Für Schraub-Befestigung.

HBS extra set
containing:
jointing bracket for
connecting two tracks

Galvanized steel.

For screw mounting

**HBS jeu complémentaire:
Manchon de raccordement
pour le raccordement
de deux rails**

Acier galvanisé.

A visser.

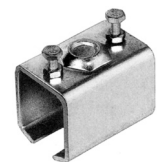

HBS-Zusatzsortiment Deckenbefestigungswinkel für 1 höhenverstellbare Muffe

Stahl, verzinkt.

Für Montage direkt unter Decken; für
deckennahe Befestigung höhenver-
stellbarer Muffen; Abstand zwischen
zwei Deckenbefestigungswinkeln
max. 700 mm.

HBS extra set
containing:
soffit fixing angle for 1 vertically
adjustable bracket

Galvanized steel.

For mounting directly unter ceilings;
for near-ceiling attachment of vertically
adjustable brackets; max. span 700 mm
between two soffit fixing angles.

**HBS jeu complémentaire:
Patte en équerre pour fixation
au plafond, pour 1 support
réglable en hauteur**

Acier galvanisé.

Pour le montage direct sous
plafond; pour supports réglables
en hauteur, fixés à proximité du
plafond; écartement maxi entre
deux pattes en équerre: 700 mm.



HBS-Zusatzsortiment Höhenverstellbare Muffe mit kurzem Gewinde

Stahl, verzinkt.

Spindel zum Ausrichten der Lauf-
schiene in der Höhe und zum Fest-
klemmen; Abstand zwischen zwei
Muffen max. 700 mm.

HBS extra set
containing:
vertically adjustable bracket,
short-spindle type

Galvanized steel.

Spindle for vertical track alignment and
clamping; max. span 700 mm between
two brackets.

**HBS jeu complémentaire:
support réglable en hauteur,
à tige filetée courte**

Acier galvanisé.

Tige filetée pour le réglage en
hauteur des rails et leur fixation;
écartement maxi entre deux
supports: 700 mm.



HBS-Zusatzsortiment Höhenverstellbare Muffe mit langem Gewinde

Stahl, verzinkt.

Spindel zum Ausrichten der Lauf-
schiene in der Höhe und zum Fest-
klemmen; Abstand zwischen zwei
Muffen max. 700 mm.

HBS extra set
containing:
vertically adjustable bracket,
long-spindle type

Galvanized steel.

Spindle for vertical track alignment and
clamping; max. span 700 mm between
two brackets.





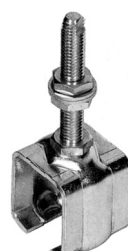

**HBS jeu complémentaire:
support réglable en hauteur,
à tige filetée longue**

Acier galvanisé.

Tige filetée pour le réglage en
hauteur des rails et leur fixation;
écartement maxi entre deux
supports: 700 mm.



**Complete sets and extra sets,
the ideal sliding door gear for interior doors up to 40 kg
Jeux complets et jeux complémentaires,
la ferrure idéale pour portes intérieures 40 kg**

		Inhalt Part Contenu	Stück No. incl. Qté.	Art.-Nr. Art.-No. Art.-No.	Beschreibung Description Description								
<table border="1"> <tr> <td>Art.-Nr. Art.-No. Art.-No.</td> <td>80031</td> </tr> <tr> <td>EAN-Nr.</td> <td>4001425 800318</td> </tr> <tr> <td>Gewicht/Garnitur Weight Poids</td> <td>0,34 kg</td> </tr> </table>		Art.-Nr. Art.-No. Art.-No.	80031	EAN-Nr.	4001425 800318	Gewicht/Garnitur Weight Poids	0,34 kg	     	2 2 2 2 1 1	81034 81010 81009 81166 81172	Einzel-Rollapparate Anschraubplatten Anschraubplatten für Seitenbefestigung Schienen-Türstopper Bodenführung Gabelschlüssel	Single hangers Fixing plates Side fixing plates Track door stops Bottom guide Wrench	Montures à galets simples Platines sur chant Platines sur plat Butées de rail Guide du bas Clé
Art.-Nr. Art.-No. Art.-No.	80031												
EAN-Nr.	4001425 800318												
Gewicht/Garnitur Weight Poids	0,34 kg												
<table border="1"> <tr> <td>Art.-Nr. Art.-No. Art.-No.</td> <td>81418</td> </tr> <tr> <td>EAN-Nr.</td> <td>4001425 814186</td> </tr> <tr> <td>Gewicht/Garnitur Weight Poids</td> <td>0,02 kg</td> </tr> </table>		Art.-Nr. Art.-No. Art.-No.	81418	EAN-Nr.	4001425 814186	Gewicht/Garnitur Weight Poids	0,02 kg		2	81172	Bodenführung zum Anschrauben; Führungsnut 5 mm breit, oder Boden- führung außen	Bottom guide for screw fixing; bottom guide groove 5 mm wide or bottom guiding on door outside	Guide du bas à visser; rainure de guidage de 5 mm d'épaisseur ou guidage du bas à l'extérieur du vantail
Art.-Nr. Art.-No. Art.-No.	81418												
EAN-Nr.	4001425 814186												
Gewicht/Garnitur Weight Poids	0,02 kg												
<table border="1"> <tr> <td>Art.-Nr. Art.-No. Art.-No.</td> <td>81264</td> </tr> <tr> <td>EAN-Nr.</td> <td>4001425 812649</td> </tr> <tr> <td>Gewicht/Garnitur Weight Poids</td> <td>1,85 kg</td> </tr> </table>		Art.-Nr. Art.-No. Art.-No.	81264	EAN-Nr.	4001425 812649	Gewicht/Garnitur Weight Poids	1,85 kg		1	81264	Verbindungs- muffe zum Verbinden zweier Laufschienen	Jointing bracket for connecting two tracks	Manchon de raccorde- ment pour le raccorde- ment de deux rails
Art.-Nr. Art.-No. Art.-No.	81264												
EAN-Nr.	4001425 812649												
Gewicht/Garnitur Weight Poids	1,85 kg												
<table border="1"> <tr> <td>Art.-Nr. Art.-No. Art.-No.</td> <td>81299</td> </tr> <tr> <td>EAN-Nr.</td> <td>4001425 812991</td> </tr> <tr> <td>Gewicht/Garnitur Weight Poids</td> <td>0,05 kg</td> </tr> </table>		Art.-Nr. Art.-No. Art.-No.	81299	EAN-Nr.	4001425 812991	Gewicht/Garnitur Weight Poids	0,05 kg		1	81299	Deckenbefestigungs- winkel für 1 höhenver- stellbare Muffe	Soffit fixing angle for 1 vertically adjustable bracket	Patte en équerre pour fixation au plafond, pour 1 support réglable en hauteur
Art.-Nr. Art.-No. Art.-No.	81299												
EAN-Nr.	4001425 812991												
Gewicht/Garnitur Weight Poids	0,05 kg												
<table border="1"> <tr> <td>Art.-Nr. Art.-No. Art.-No.</td> <td>81261</td> </tr> <tr> <td>EAN-Nr.</td> <td>4001425 812618</td> </tr> <tr> <td>Gewicht/Garnitur Weight Poids</td> <td>0,06 kg</td> </tr> </table>		Art.-Nr. Art.-No. Art.-No.	81261	EAN-Nr.	4001425 812618	Gewicht/Garnitur Weight Poids	0,06 kg		1	81261	Höhenverstellbare Muffe, mit kurzem Gewinde	Bracket, vertically ajustable, short-spindle type	Support, réglable en hauteur, à tige filetée courte
Art.-Nr. Art.-No. Art.-No.	81261												
EAN-Nr.	4001425 812618												
Gewicht/Garnitur Weight Poids	0,06 kg												
<table border="1"> <tr> <td>Art.-Nr. Art.-No. Art.-No.</td> <td>81262</td> </tr> <tr> <td>EAN-Nr.</td> <td>4001425 812625</td> </tr> <tr> <td>Gewicht/Garnitur Weight Poids</td> <td>0,07 kg</td> </tr> </table>		Art.-Nr. Art.-No. Art.-No.	81262	EAN-Nr.	4001425 812625	Gewicht/Garnitur Weight Poids	0,07 kg		1	81262	Höhenverstellbare Muffe, mit langem Gewinde	Bracket, vertically ajustable, long-spindle type	Support, réglable en hauteur, à tige filetée longue
Art.-Nr. Art.-No. Art.-No.	81262												
EAN-Nr.	4001425 812625												
Gewicht/Garnitur Weight Poids	0,07 kg												

Komplett-Bausätze und Zusatzsortimente

Der ideale Beschlag für Zimmertüren bis 60 kg

HBS-Komplett-Bausatz 185 cm für 1 Schiebetür

Schienenlänge 1,85 m;
Türgewicht bis 60 kg.

Komplett incl. Befestigungs-
material und Montage-
anleitung in Kunststoffhülle
eingeschrumpft.

HBS complete set 185 cm for 1 sliding door

Length of track 1,85 m;
Door weight up to 60 kg.

Complete set incl. fixing
screws and mounting
instruction shrink packed

HBS jeu complet 185 cm 1 porte à coulisse

Longueur du rail 1,85 m;
Poids de porte 60 kg maxi.

Garniture complète avec
visserie et instruction de
montage sous sachet sous
vide.



HBS-Komplett-Bausatz 230 cm für 1 Schiebetür

Schienenlänge 2,30 m;
Türgewicht bis 60 kg.

Komplett incl. Befestigungs-
material und Montage-
anleitung in Kunststoffhülle
eingeschrumpft.

HBS complete set 230 cm for 1 sliding door

Length of track 2,30 m;
Door weight up to 60 kg.

Complete set incl. fixing
screws and mounting
instruction shrink packed

HBS jeu complet 230 cm 1 porte à coulisse

Longueur du rail 2,30 m;
Poids de porte 60 kg maxi.

Garniture complète avec
visserie et instruction de
montage sous sachet sous
vide.



HBS-Zusatzsortiment 1 Stahl-Laufschiene

Länge 1,85 m
Türgewicht bis 60 kg.

HBS extra set 1 steel track

length 1,85 m
Door weight up to 60 kg.

HBS jeu complémentaire: 1 rail acier

longueur 1,85 m
Poids de porte 60 kg maxi.



HBS-Zusatzsortiment Anschraubplatte zur Rollapparat-Befestigung

Stahl, verzinkt.

Mit Gewinde für Befestigungs-
schraube; zur Stirnmontage auf
Massiv-Holz

HBS extra set plate for hanger attachment

Galvanized steel.

Threaded for attaching screw; for top
mounting on solid wood.

HBS jeu complémentaire: Platine à visser pour la fixa- tion de montures à galets

Acier galvanisé.

Avec taraudage pour vis de
fixation; à monter sur chant sur
bois massif.



HBS-Zusatzsortiment Schienen-Türstopper zum Befestigen in der Laufschiene

Stahl, verzinkt; Gummipuffer.

Zum Stoppen leichter Türen.

HBS extra set track door stop for in-track mounting

Galvanized steel; rubber buffer.

For stopping lightweight doors.











HBS jeu complémentaire: Butoir de porte à fixer dans le rail

Acier galvanisé; tampon
en caoutchouc.

Pour l'arrêt de portes
courantes.



**Complete sets and extra sets,
the ideal sliding door gear for interior doors up to 60 kg
Jeux complets et jeux complémentaires,
la ferrure idéale pour portes intérieures 60 kg**

	Inhalt Part Contenu	Stück No. incl. Qté.	Art.-Nr. Art.-No. Art.-No.	Beschreibung Description Description								
<table border="1"> <tr> <td>Art.-Nr. Art.-No. Art.-No.</td> <td>80006</td> </tr> <tr> <td>EAN-Nr.</td> <td>4001425 800066</td> </tr> <tr> <td>Gewicht/Garnitur Weight Poids</td> <td>2,28 kg</td> </tr> </table>	Art.-Nr. Art.-No. Art.-No.	80006	EAN-Nr.	4001425 800066	Gewicht/Garnitur Weight Poids	2,28 kg	    	1	82042	Stahl-Laufschiene sendz. verzinkt, 1,85 m	Track, steel galvanized Sendzimir, 1,85 m	Rail galvanisé Sendzimir, 1,85 m
Art.-Nr. Art.-No. Art.-No.	80006											
EAN-Nr.	4001425 800066											
Gewicht/Garnitur Weight Poids	2,28 kg											
		2	81036	Doppel-Rollapparate	Double hangers	Montures à 2 galets						
		5	81271	Wandbefestigungswinkel	Side fixing brackets	Supports équerres						
		1	81172	Bodenführung	Bottom guide	Guide du bas						
		1		Gabelschlüssel	Wrench	Clé						
<table border="1"> <tr> <td>Art.-Nr. Art.-No. Art.-No.</td> <td>80007</td> </tr> <tr> <td>EAN-Nr.</td> <td>4001425 800073</td> </tr> <tr> <td>Gewicht/Garnitur Weight Poids</td> <td>2,70 kg</td> </tr> </table>	Art.-Nr. Art.-No. Art.-No.	80007	EAN-Nr.	4001425 800073	Gewicht/Garnitur Weight Poids	2,70 kg	    	1	82057	Stahl-Laufschiene sendz. verzinkt, 2,30 m	Track, steel galvanized Sendzimir, 2,30 m	Rail galvanisé Sendzimir, 2,30 m
Art.-Nr. Art.-No. Art.-No.	80007											
EAN-Nr.	4001425 800073											
Gewicht/Garnitur Weight Poids	2,70 kg											
		2	81036	Doppel-Rollapparate	Double hangers	Montures à 2 galets						
		6	81271	Wandbefestigungswinkel	Side fixing brackets	Supports équerres						
		1	81172	Bodenführung	Bottom guide	Guide du bas						
		1		Gabelschlüssel	Wrench	Clé						
<table border="1"> <tr> <td>Art.-Nr. Art.-No. Art.-No.</td> <td>82042</td> </tr> <tr> <td>EAN-Nr.</td> <td>4001425 820422</td> </tr> <tr> <td>Gewicht/Garnitur Weight Poids</td> <td>1,85 kg</td> </tr> </table>	Art.-Nr. Art.-No. Art.-No.	82042	EAN-Nr.	4001425 820422	Gewicht/Garnitur Weight Poids	1,85 kg		1	82042	Stahl-Laufschiene sendz. verzinkt Länge 1,85 m	Track, steel galvanized Sendzimir length 1,85 m	Rail galvanisé Sendzimir longueur 1,85 m
Art.-Nr. Art.-No. Art.-No.	82042											
EAN-Nr.	4001425 820422											
Gewicht/Garnitur Weight Poids	1,85 kg											
<table border="1"> <tr> <td>Art.-Nr. Art.-No. Art.-No.</td> <td>81010</td> </tr> <tr> <td>EAN-Nr.</td> <td>4001425 810102</td> </tr> <tr> <td>Gewicht/Garnitur Weight Poids</td> <td>0,01 kg</td> </tr> </table>	Art.-Nr. Art.-No. Art.-No.	81010	EAN-Nr.	4001425 810102	Gewicht/Garnitur Weight Poids	0,01 kg		1	81010	Anschraubplatte	Fixing plate	Platine sur chant
Art.-Nr. Art.-No. Art.-No.	81010											
EAN-Nr.	4001425 810102											
Gewicht/Garnitur Weight Poids	0,01 kg											
<table border="1"> <tr> <td>Art.-Nr. Art.-No. Art.-No.</td> <td>81166</td> </tr> <tr> <td>EAN-Nr.</td> <td>4001425 811666</td> </tr> <tr> <td>Gewicht/Garnitur Weight Poids</td> <td>0,01 kg</td> </tr> </table>	Art.-Nr. Art.-No. Art.-No.	81166	EAN-Nr.	4001425 811666	Gewicht/Garnitur Weight Poids	0,01 kg		1	81166	Bodenführung	Bottom guide	Guide du bas
Art.-Nr. Art.-No. Art.-No.	81166											
EAN-Nr.	4001425 811666											
Gewicht/Garnitur Weight Poids	0,01 kg											

Komplett-Bausätze und Zusatzsortimente

Der ideale Beschlag für Zimmertüren bis 60 kg

HBS-Zusatzsortiment 80005 2 Doppel-Rollapparate für 1 zusätzliche Tür

Ohne Laufschiene.
Türgewicht bis 60 kg.

Komplett incl.
Befestigungsmaterial im Beutel ein-
geschweißt.

HBS extra set 80005 containing: 2 double hangers for 1 additional door

Without track.
Door weight up to 60 kg.

Complete set incl. fixing
screws in plastic bag.

HBS jeu complémen- taire 80005: 2 montures à galets doubles pour 1 porte additionelle

Sans rail.
Poids de porte 60 kg maxi.

Garniture complète
avec visserie sous
sachet plastique .



HBS-Zusatzsortiment 81418 Bodenführungen für 1 zusätzliche Tür

Mit 5 mm breiter Führungsnut
(unten) **oder** Führung außen
am Türblatt ohne Führungsnut.

Komplett incl. Befestigungs-
material.

HBS extra set 81418 containing: bottom guides for 1 additional door

With 5 mm wide bottom
guide groove **or** guiding
on door outside without
grooving.

Complete set incl.
fixing screws.

HBS jeu complémen- taire 81418: guides du bas pour 1 porte additionelle

Avec rainure de guidage de
5 mm d'épaisseur (en bas)
ou guidage sans rainure à
l'extérieur du vantail.

Garniture complète
avec visserie.



HBS-Zusatzsortiment Verbindungsuffe zum Verbinden zweier Laufschiene

Stahl, verzinkt.

Für Schraub-Befestigung.

HBS extra set containing: jointing bracket for connecting two tracks

Galvanized steel.

For screw mounting

HBS jeu complémentaire: Manchon de raccordement pour le raccordement de deux rails

Acier galvanisé.

A visser.

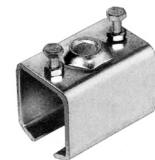

HBS-Zusatzsortiment Deckenbefestigungswinkel für 1 höhenverstellbare Muffe

Stahl, verzinkt.

Für Montage direkt unter Decken; für
deckennahe Befestigung höhenver-
stellbarer Muffen; Abstand zwischen
zwei Deckenbefestigungswinkeln
max. 700 mm.

HBS extra set containing: soffit fixing angle for 1 vertically adjustable bracket

Galvanized steel.

For mounting directly unter ceilings;
for near-ceiling attachment of vertically
adjustable brackets; max. span 700 mm
between two soffit fixing angles.

HBS jeu complémentaire: Patte en équerre pour fixation au plafond, pour 1 support réglable en hauteur

Acier galvanisé.

Pour le montage direct sous
plafond; pour supports réglables
en hauteur, fixés à proximité du
plafond; écartement maxi entre
deux pattes en équerre: 700 mm.



HBS-Zusatzsortiment Höhenverstellbare Muffe mit kurzem Gewinde

Stahl, verzinkt.

Spindel zum Ausrichten der Lauf-
schiene in der Höhe und zum Fest-
klemmen; Abstand zwischen zwei
Muffen max. 700 mm.

HBS extra set containing: vertically adjustable bracket, short-spindle type

Galvanized steel.

Spindle for vertical track alignment and
clamping; max. span 700 mm between
two brackets.

HBS jeu complémentaire: support réglable en hauteur, à tige filetée courte

Acier galvanisé.

Tige filetée pour le réglage en
hauteur des rails et leur fixation;
écartement maxi entre deux
supports: 700 mm.



HBS-Zusatzsortiment Höhenverstellbare Muffe mit langem Gewinde

Stahl, verzinkt.

Spindel zum Ausrichten der Lauf-
schiene in der Höhe und zum Fest-
klemmen; Abstand zwischen zwei
Muffen max. 700 mm.

HBS extra set containing: vertically adjustable bracket, long-spindle type

Galvanized steel.

Spindle for vertical track alignment and
clamping; max. span 700 mm between
two brackets.



HBS jeu complémentaire: support réglable en hauteur, à tige filetée longue

Acier galvanisé.

Tige filetée pour le réglage en
hauteur des rails et leur fixation;
écartement maxi entre deux
supports: 700 mm.



**Complete sets and extra sets,
the ideal sliding door gear for interior doors up to 60 kg**
**Jeux complets et jeux complémentaires,
la ferrure idéale pour portes intérieures 60 kg**

		Inhalt Part Contenu	Stück No. incl. Qté.	Art.-Nr. Art.-No. Art.-No.	Beschreibung Description Description		
Art.-Nr. Art.-No. Art.-No.	80005		2	81036	Doppel-Rollapparate	Double hangers	Montures à galets doubles
EAN-Nr.	4001425 800059		1	81172	Bodenführung zum Anschrauben; Führungsnut 5 mm breit, oder Bodenführung außen	Bottom guide for screw fixing; bottom guide groove 5 mm wide or bottom guiding on door outside	Guide du bas à visser; rainure de guidage de 5 mm d'épaisseur ou guidage du bas à l'extérieur du vantail
Gewicht/Garnitur Weight Poids	0,27 kg		1		Gabelschlüssel	Wrench	Clé
Art.-Nr. Art.-No. Art.-No.	81418		2	81172	Bodenführung zum Anschrauben; Führungsnut 5 mm breit, oder Bodenführung außen	Bottom guide for screw fixing; bottom guide groove 5 mm wide or bottom guiding on door outside	Guide du bas à visser; rainure de guidage de 5 mm d'épaisseur ou guidage du bas à l'extérieur du vantail
EAN-Nr.	4001425 814186						
Gewicht/Garnitur Weight Poids	0,02 kg						
Art.-Nr. Art.-No. Art.-No.	81264		1	81264	Verbindungs- muffe zum Verbinden zweier Laufschiene	Jointing bracket for connecting two tracks	Manchon de raccorde- ment pour le raccorde- ment de deux rails
EAN-Nr.	4001425 812649						
Gewicht/Garnitur Weight Poids	1,85 kg						
Art.-Nr. Art.-No. Art.-No.	81299		1	81299	Deckenbefestigungs- winkel für 1 höhenver- stellbare Muffe	Soffit fixing angle for 1 vertically adjustable bracket	Patte en équerre pour fixation au plafond, pour 1 support réglable en hauteur
EAN-Nr.	4001425 812991						
Gewicht/Garnitur Weight Poids	0,05 kg						
Art.-Nr. Art.-No. Art.-No.	81261		1	81261	Höhenverstellbare Muffe, mit kurzem Gewinde	Bracket, vertically ajustable, short-spindle type	Support, réglable en hauteur, à tige filetée courte
EAN-Nr.	4001425 812618						
Gewicht/Garnitur Weight Poids	0,06 kg						
Art.-Nr. Art.-No. Art.-No.	81262		1	81262	Höhenverstellbare Muffe, mit langem Gewinde	Bracket, vertically ajustable, long-spindle type	Support, réglable en hauteur, à tige filetée longue
EAN-Nr.	4001425 812625						
Gewicht/Garnitur Weight Poids	0,07 kg						

Zimmer-Schiebetürbeschlag - superleise

für Türgewichte von 45 kg - 80 kg

**Sliding door gears - supersoft
for door weights from 45 kg to 80 kg**

**Ferrures de portes coulissantes - silencieuse
pour portes de 45 kg à 80 kg**

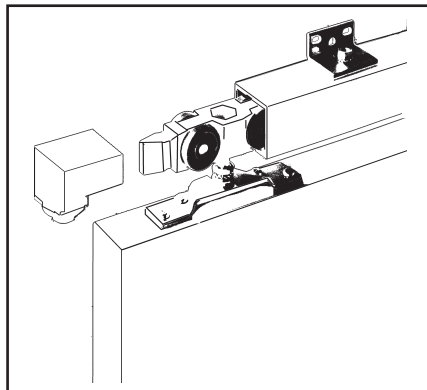

- Schienenlänge 1,50 m, 1,90 m und 2,40 m
- Laufschiene Aluminium
- Auch für den Außenbereich bestens geeignet
- umfassende Beratung bis zur Endmontage durch verständliche Montageanleitungen in Wort und Bild
- komplett incl. Befestigungsmaterial und Montageanleitung in Kunststoffhülle eingeschumpft

- length of track 1,50 m, 1,90 m and 2,40 m
- track aluminium
- also suitable for outdoor applications
- clear mounting instructions with text and illustration offer complete consulting until final assembly
- complete sets incl. fixing screws and mounting instruction shrink packed
- longueur du rail 1,50 m, 1,90 m et 2,40 m
- rail en aluminium
- poses à l'extérieur possibles
- l'instruction de montage complète (texte et illustrations) est conçue pour une information détaillée jusqu' à la pose finale
- garnitures complètes avec visserie et instruction de montage sous sachet sous vide

Komplett-Bausätze und Zusatzsortimente

Der ideale Beschlag für Zimmertüren bis 45 kg

HBS-Komplett-Bausatz 150 cm für 1 Schiebetür

Schienenlänge 1,50 m;
Türgewicht bis 45 kg.

Komplett incl. Befestigungs-
material und Montage-
anleitung in Kunststoffhülle
eingeschrumpft.

HBS complete set 150 cm for 1 sliding door

Length of track 1,50 m;
Door weight up to 45 kg.

Complete set incl. fixing
screws and mounting
instruction shrink packed

HBS jeu complet 150 cm 1 porte à coulisse

Longueur du rail 1,50 m;
Poids de porte 45 kg maxi.

Garniture complète avec
visserie et instruction de
montage sous sachet sous
vide.



HBS-Komplett-Bausatz 190 cm für 1 Schiebetür

Schienenlänge 1,90 m;
Türgewicht bis 45 kg.

Komplett incl. Befestigungs-
material und Montage-
anleitung in Kunststoffhülle
eingeschrumpft.

HBS complete set 190 cm for 1 sliding door

Length of track 1,90 m;
Door weight up to 45 kg.

Complete set incl. fixing
screws and mounting
instruction shrink packed

HBS jeu complet 190 cm 1 porte à coulisse

Longueur du rail 1,90 m;
Poids de porte 45 kg maxi.

Garniture complète avec
visserie et instruction de
montage sous sachet sous
vide.



HBS-Komplett-Bausatz 240 cm für 1 Schiebetür

Schienenlänge 2,40 m;
Türgewicht bis 45 kg.

Komplett incl. Befestigungs-
material und Montage-
anleitung in Kunststoffhülle
eingeschrumpft.

HBS complete set 240 cm for 1 sliding door

Length of track 2,40 m;
Door weight up to 45 kg.

Complete set incl. fixing
screws and mounting
instruction shrink packed











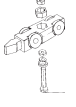





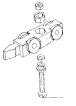

HBS jeu complet 240 cm 1 porte à coulisse

Longueur du rail 2,40 m;
Poids de porte 45 kg maxi.

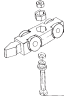
Garniture complète avec
visserie et instruction de
montage sous sachet sous
vide.



**Complete sets and extra sets,
the ideal sliding door gear for interior doors up to 45 kg
Jeux complets et jeux complémentaires,
la ferrure idéale pour portes intérieures 45 kg**

		Inhalt Part Contenu	Stück No. incl. Qté.	Art.-Nr. Art.-No. Art.-No.	Beschreibung Description Description								
<table border="1"> <tr> <td>Art.-Nr. Art.-No. Art.-No.</td> <td>80049</td> </tr> <tr> <td>EAN-Nr.</td> <td>4001425 800493</td> </tr> <tr> <td>Gewicht/Garnitur Weight Poids</td> <td>1,65 kg</td> </tr> </table>		Art.-Nr. Art.-No. Art.-No.	80049	EAN-Nr.	4001425 800493	Gewicht/Garnitur Weight Poids	1,65 kg	      	<p>1</p> <p>2</p> <p>2</p> <p>2</p> <p>1</p> <p>4</p> <p>1</p>	<p>82161</p> <p>80161</p> <p>80167</p> <p>80166</p> <p>81172</p> <p>81269</p> <p></p>	<p>Aluminium Laufschiene, 1,50 m</p> <p>Doppel-Rollapparate</p> <p>Anschraubplatten</p> <p>Endfeststeller</p> <p>Bodenführung</p> <p>Wandbefestigungs- winkel</p> <p>Gabelschlüssel</p>	<p>Track, Aluminium, 1,50 m</p> <p>Double hangers</p> <p>Fixing plates</p> <p>Track end buffer</p> <p>Bottom guide</p> <p>Side fixing brackets</p> <p>Wrench</p>	<p>Rail Aluminium, 1,50 m</p> <p>Montures à galets doubles</p> <p>Plantines sur chant</p> <p>Butée pour rail</p> <p>Guide du bas</p> <p>Supports équerres</p> <p>Clé</p>
Art.-Nr. Art.-No. Art.-No.	80049												
EAN-Nr.	4001425 800493												
Gewicht/Garnitur Weight Poids	1,65 kg												
<table border="1"> <tr> <td>Art.-Nr. Art.-No. Art.-No.</td> <td>80050</td> </tr> <tr> <td>EAN-Nr.</td> <td>4001425 800509</td> </tr> <tr> <td>Gewicht/Garnitur Weight Poids</td> <td>1,98 kg</td> </tr> </table>		Art.-Nr. Art.-No. Art.-No.	80050	EAN-Nr.	4001425 800509	Gewicht/Garnitur Weight Poids	1,98 kg	      	<p>1</p> <p>2</p> <p>2</p> <p>2</p> <p>1</p> <p>4</p> <p>1</p>	<p>82168</p> <p>80161</p> <p>80167</p> <p>80166</p> <p>81172</p> <p>81269</p> <p></p>	<p>Aluminium Laufschiene, 1,90 m</p> <p>Doppel-Rollapparate</p> <p>Anschraubplatten</p> <p>Endfeststeller</p> <p>Bodenführung</p> <p>Wandbefestigungs- winkel</p> <p>Gabelschlüssel</p>	<p>Track, Aluminium, 1,90 m</p> <p>Double hangers</p> <p>Fixing plates</p> <p>Track end buffer</p> <p>Bottom guide</p> <p>Side fixing brackets</p> <p>Wrench</p>	<p>Rail Aluminium, 1,90 m</p> <p>Montures à galets doubles</p> <p>Plantines sur chant</p> <p>Butée pour rail</p> <p>Guide du bas</p> <p>Supports équerres</p> <p>Clé</p>
Art.-Nr. Art.-No. Art.-No.	80050												
EAN-Nr.	4001425 800509												
Gewicht/Garnitur Weight Poids	1,98 kg												
<table border="1"> <tr> <td>Art.-Nr. Art.-No. Art.-No.</td> <td>80051</td> </tr> <tr> <td>EAN-Nr.</td> <td>4001425 800516</td> </tr> <tr> <td>Gewicht/Garnitur Weight Poids</td> <td>2,28 kg</td> </tr> </table>		Art.-Nr. Art.-No. Art.-No.	80051	EAN-Nr.	4001425 800516	Gewicht/Garnitur Weight Poids	2,28 kg	      	<p>1</p> <p>2</p> <p>2</p> <p>2</p> <p>1</p> <p>4</p> <p>1</p>	<p>82160</p> <p>80161</p> <p>80167</p> <p>80166</p> <p>81172</p> <p>81269</p> <p></p>	<p>Aluminium Laufschiene, 2,40 m</p> <p>Doppel-Rollapparate</p> <p>Anschraubplatten</p> <p>Endfeststeller</p> <p>Bodenführung</p> <p>Wandbefestigungs- winkel</p> <p>Gabelschlüssel</p>	<p>Track, Aluminium, 2,40 m</p> <p>Double hangers</p> <p>Fixing plates</p> <p>Track end buffer</p> <p>Bottom guide</p> <p>Side fixing brackets</p> <p>Wrench</p>	<p>Rail Aluminium, 2,40 m</p> <p>Montures à galets doubles</p> <p>Plantines sur chant</p> <p>Butée pour rail</p> <p>Guide du bas</p> <p>Supports équerres</p> <p>Clé</p>
Art.-Nr. Art.-No. Art.-No.	80051												
EAN-Nr.	4001425 800516												
Gewicht/Garnitur Weight Poids	2,28 kg												

Komplett-Bausätze und Zusatzsortimente

Der ideale Beschlag für Zimmertüren bis 80 kg

HBS-Komplett-Bausatz 150 cm für 1 Schiebetür

Schielenlänge 1,50 m;
Türgewicht bis 80 kg.

Komplett incl. Befestigungs-
material und Montage-
anleitung in Kunststoffhülle
eingeschrumpft.

HBS complete set 150 cm for 1 sliding door

Length of track 1,50 m;
Door weight up to 80 kg.

Complete set incl. fixing
screws and mounting
instruction shrink packed

HBS jeu complet 150 cm 1 porte à coulisse

Longueur du rail 1,50 m;
Poids de porte 80 kg maxi.

Garniture complète avec
visserie et instruction de
montage sous sachet sous
vide.

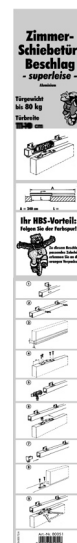

HBS-Komplett-Bausatz 190 cm für 1 Schiebetür

Schielenlänge 1,90 m;
Türgewicht bis 80 kg.

Komplett incl. Befestigungs-
material und Montage-
anleitung in Kunststoffhülle
eingeschrumpft.

HBS complete set 190 cm for 1 sliding door

Length of track 1,90 m;
Door weight up to 80 kg.

Complete set incl. fixing
screws and mounting
instruction shrink packed

HBS jeu complet 190 cm 1 porte à coulisse

Longueur du rail 1,90 m;
Poids de porte 80 kg maxi.

Garniture complète avec
visserie et instruction de
montage sous sachet sous
vide.



HBS-Komplett-Bausatz 240 cm für 1 Schiebetür

Schielenlänge 2,40 m;
Türgewicht bis 80 kg.

Komplett incl. Befestigungs-
material und Montage-
anleitung in Kunststoffhülle
eingeschrumpft.

HBS complete set 240 cm for 1 sliding door

Length of track 2,40 m;
Door weight up to 80 kg.

Complete set incl. fixing
screws and mounting
instruction shrink packed





















HBS jeu complet 240 cm 1 porte à coulisse

Longueur du rail 2,40 m;
Poids de porte 80 kg maxi.

Garniture complète avec
visserie et instruction de
montage sous sachet sous
vide.



**Complete sets and extra sets,
the ideal sliding door gear for interior doors up to 80 kg**
**Jeux complets et jeux complémentaires,
la ferrure idéale pour portes intérieures 80 kg**

		Inhalt Part Contenu	Stück No. incl. Qté.	Art.-Nr. Art.-No. Art.-No.	Beschreibung Description Description								
<table border="1"> <tr> <td>Art.-Nr. Art.-No. Art.-No.</td> <td>80054</td> </tr> <tr> <td>EAN-Nr.</td> <td>4001425 800547</td> </tr> <tr> <td>Gewicht/Garnitur Weight Poids</td> <td>1,75 kg</td> </tr> </table>		Art.-Nr. Art.-No. Art.-No.	80054	EAN-Nr.	4001425 800547	Gewicht/Garnitur Weight Poids	1,75 kg	      	<p>1</p> <p>2</p> <p>2</p> <p>2</p> <p>1</p> <p>4</p> <p>1</p>	<p>82161</p> <p>80162</p> <p>80167</p> <p>80166</p> <p>81172</p> <p>81269</p> <p></p>	<p>Aluminium Laufschiene, 1,50 m</p> <p>Doppel-Rollapparate</p> <p>Anschraubplatten</p> <p>Endfeststeller</p> <p>Bodenführung</p> <p>Wandbefestigungs- winkel</p> <p>Gabelschlüssel</p>	<p>Track, Aluminium, 1,50 m</p> <p>Double hangers</p> <p>Fixing plates</p> <p>Track end buffer</p> <p>Bottom guide</p> <p>Side fixing brackets</p> <p>Wrench</p>	<p>Rail Aluminium, 1,50 m</p> <p>Montures à galets doubles</p> <p>Plantines sur chant</p> <p>Butée pour rail</p> <p>Guide du bas</p> <p>Supports équerres</p> <p>Clé</p>
Art.-Nr. Art.-No. Art.-No.	80054												
EAN-Nr.	4001425 800547												
Gewicht/Garnitur Weight Poids	1,75 kg												
<table border="1"> <tr> <td>Art.-Nr. Art.-No. Art.-No.</td> <td>80055</td> </tr> <tr> <td>EAN-Nr.</td> <td>4001425 800554</td> </tr> <tr> <td>Gewicht/Garnitur Weight Poids</td> <td>2,08 kg</td> </tr> </table>		Art.-Nr. Art.-No. Art.-No.	80055	EAN-Nr.	4001425 800554	Gewicht/Garnitur Weight Poids	2,08 kg	      	<p>1</p> <p>2</p> <p>2</p> <p>2</p> <p>1</p> <p>4</p> <p>1</p>	<p>82168</p> <p>80162</p> <p>80167</p> <p>80166</p> <p>81172</p> <p>81269</p> <p></p>	<p>Aluminium Laufschiene, 1,90 m</p> <p>Doppel-Rollapparate</p> <p>Anschraubplatten</p> <p>Endfeststeller</p> <p>Bodenführung</p> <p>Wandbefestigungs- winkel</p> <p>Gabelschlüssel</p>	<p>Track, Aluminium, 1,90 m</p> <p>Double hangers</p> <p>Fixing plates</p> <p>Track end buffer</p> <p>Bottom guide</p> <p>Side fixing brackets</p> <p>Wrench</p>	<p>Rail Aluminium, 1,90 m</p> <p>Montures à galets doubles</p> <p>Plantines sur chant</p> <p>Butée pour rail</p> <p>Guide du bas</p> <p>Supports équerres</p> <p>Clé</p>
Art.-Nr. Art.-No. Art.-No.	80055												
EAN-Nr.	4001425 800554												
Gewicht/Garnitur Weight Poids	2,08 kg												
<table border="1"> <tr> <td>Art.-Nr. Art.-No. Art.-No.</td> <td>80056</td> </tr> <tr> <td>EAN-Nr.</td> <td>4001425 800561</td> </tr> <tr> <td>Gewicht/Garnitur Weight Poids</td> <td>2,38 kg</td> </tr> </table>		Art.-Nr. Art.-No. Art.-No.	80056	EAN-Nr.	4001425 800561	Gewicht/Garnitur Weight Poids	2,38 kg	      	<p>1</p> <p>2</p> <p>2</p> <p>2</p> <p>1</p> <p>4</p> <p>1</p>	<p>82160</p> <p>80162</p> <p>80167</p> <p>80166</p> <p>81172</p> <p>81269</p> <p></p>	<p>Aluminium Laufschiene, 2,40 m</p> <p>Doppel-Rollapparate</p> <p>Anschraubplatten</p> <p>Endfeststeller</p> <p>Bodenführung</p> <p>Wandbefestigungs- winkel</p> <p>Gabelschlüssel</p>	<p>Track, Aluminium, 2,40 m</p> <p>Double hangers</p> <p>Fixing plates</p> <p>Track end buffer</p> <p>Bottom guide</p> <p>Side fixing brackets</p> <p>Wrench</p>	<p>Rail Aluminium, 2,40 m</p> <p>Montures à galets doubles</p> <p>Plantines sur chant</p> <p>Butée pour rail</p> <p>Guide du bas</p> <p>Supports équerres</p> <p>Clé</p>
Art.-Nr. Art.-No. Art.-No.	80056												
EAN-Nr.	4001425 800561												
Gewicht/Garnitur Weight Poids	2,38 kg												

Komplett-Bausätze und Zusatzsortimente

Der ideale Beschlag für Zimmertüren bis 45 kg und bis 80 kg

HBS-Zusatzsortiment Aluminium-Laufschiene, gelocht

Länge 5,00 m
Türgewicht bis 80 kg.

HBS extra set Aluminium track, pre-drilled

length 5,00 m
Door weight up to 80 kg.

HBS jeu complémentaire: Rail aluminium, perforé

longueur 5,00 m
Poids de porte 80 kg maxi.



HBS-Zusatzsortiment 80058 2 Doppel-Rollapparate für 1 zusätzliche Tür

Türgewicht bis 45 kg.

Komplett incl.
Befestigungsmaterial.

HBS extra set 80058 containing: 2 double-wheel hangers for 1 additional door

Door weight up to 45 kg.

Complete set
incl. fixing screws.

HBS jeu complémentaire 80058: 2 montures à galet double pour 1 porte additionelle

Poids de porte 45 kg maxi.

Garniture complète
avec visserie.



HBS-Zusatzsortiment 80059 2 Doppel-Rollapparate für 1 zusätzliche Tür

Türgewicht bis 80 kg.

Komplett incl.
Befestigungsmaterial.

HBS extra set 80059 containing: 2 double-wheel hangers for 1 additional door

Door weight up to 80 kg.

Complete set
incl. fixing screws.













HBS jeu complémentaire 80059: 2 montures à galet double pour 1 porte additionelle

Poids de porte 80 kg maxi.

Garniture complète
avec visserie.



**Complete sets and extra sets,
the ideal sliding door gear for interior doors up to 45 kg and up to 80 kg**
**Jeux complets et jeux complémentaires,
la ferrure idéale pour portes intérieures 45 kg et 80 kg**

		Inhalt Part Contenu	Stück No. incl. Qté.	Art.-Nr. Art.-No. Art.-No.	Beschreibung Description Description							
<table border="1"> <tr> <td>Art.-Nr. Art.-No. Art.-No.</td> <td>82154</td> </tr> <tr> <td>EAN-Nr.</td> <td>4 001425 821542</td> </tr> <tr> <td>Gewicht/Garnitur Weight Poids</td> <td>2,20 kg</td> </tr> </table>	Art.-Nr. Art.-No. Art.-No.	82154	EAN-Nr.	4 001425 821542	Gewicht/Garnitur Weight Poids	2,20 kg		1	82154	Aluminium Laufschiene, 5,00 m	Track, Aluminium, 5,00 m	Rail Aluminium, 5,00 m
Art.-Nr. Art.-No. Art.-No.	82154											
EAN-Nr.	4 001425 821542											
Gewicht/Garnitur Weight Poids	2,20 kg											
<table border="1"> <tr> <td>Art.-Nr. Art.-No. Art.-No.</td> <td>80058</td> </tr> <tr> <td>EAN-Nr.</td> <td>4 001425 800585</td> </tr> <tr> <td>Gewicht/Garnitur Weight Poids</td> <td>0,54 kg</td> </tr> </table>	Art.-Nr. Art.-No. Art.-No.	80058	EAN-Nr.	4 001425 800585	Gewicht/Garnitur Weight Poids	0,54 kg	     	2 2 2 1 4 1	80161 80167 80166 81172 81269	Doppel-Rollapparate Anschraubplatten Endfeststeller Bodenführung Wandbefestigungs- winkel Gabelschlüssel	Double hangers Fixing plates Track end buffer Bottom guide Side fixing brackets Wrench	Montures à galets doubles Plantines sur chant Butée pour rail Guide du bas Supports équerres Clé
Art.-Nr. Art.-No. Art.-No.	80058											
EAN-Nr.	4 001425 800585											
Gewicht/Garnitur Weight Poids	0,54 kg											
<table border="1"> <tr> <td>Art.-Nr. Art.-No. Art.-No.</td> <td>80059</td> </tr> <tr> <td>EAN-Nr.</td> <td>4 001425 800592</td> </tr> <tr> <td>Gewicht/Garnitur Weight Poids</td> <td>0,54 kg</td> </tr> </table>	Art.-Nr. Art.-No. Art.-No.	80059	EAN-Nr.	4 001425 800592	Gewicht/Garnitur Weight Poids	0,54 kg	     	2 2 2 1 4 1	80162 80167 80166 81172 81269	Doppel-Rollapparate Anschraubplatten Endfeststeller Bodenführung Wandbefestigungs- winkel Gabelschlüssel	Double hangers Fixing plates Track end buffer Bottom guide Side fixing brackets Wrench	Montures à galets doubles Plantines sur chant Butée pour rail Guide du bas Supports équerres Clé
Art.-Nr. Art.-No. Art.-No.	80059											
EAN-Nr.	4 001425 800592											
Gewicht/Garnitur Weight Poids	0,54 kg											

Falttürbeschläge

Folding door fittings

Ferrures pour portes pliantes

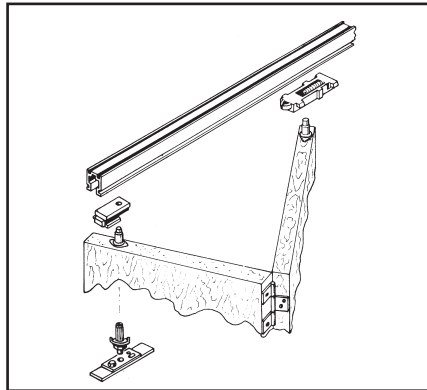

- für zweiflügelige Lamellentüren bis 2 m Höhe
- Schienenlänge 0,80 m und 1,20 m
- der ideale Beschlag für Garderoben-, Flur-, Kleider- und viele andere Schränke aus Holz
- sehr leichtgängig
- geräuscharm in wartungsfreier Aluminium-Laufschiene
- umfassende Beratung bis zur Endmontage durch verständliche Montageanleitungen in Wort und Bild
- komplett incl. Befestigungsmaterial und Montageanleitung in Kunststoffhülle eingeschumpft

- for 2-leaf louver doors up to 2 m height
- length of track 0,80 and 1,20 m
- the ideal hardware for wardrobes, closets, cupboards and other doors of wood
- very easy operation
- noise-free movement in maintenance-free aluminium track
- clear mounting instructions with text and illustration offer complete consulting until final assembly
- complete sets incl. fixing screws and mounting instruction shrink
- pour portes à lamelles à deux vantaux, hauteur 2 m
- longueur du rail 0,80 m et 1,20 m
- la ferrure idéale pour garde-robes, placards et d'autres portes en bois
- mouvement très aisé
- fonctionnement silencieux avec rails en aluminium sans entretien
- l'instruction de montage complète (texte et illustrations) est conçue pour une information détaillée jusqu' à la pose finale
- garnitures complètes avec visserie et instruction de montage sous sachet sous vide

Komplett-Bausätze und Zusatzsortimente

Der ideale Beschlag für Lamellen-Faltdüren bis 2 m Höhe

HBS-Komplett-Bausatz 80026 für zweiflügelige Lamellen-Faltdüren

Schienenlänge 0,80 m;
Türhöhe bis 2 m.

Komplett incl. Befestigungsmaterial und Montageanleitung in Kunststoffhülle eingeschumpft.

HBS complete set 80026 for 2-leaf folding louver doors

Length of track 0,80 m;
Height of door up to 2 m.

Complete set incl. fixing screws and mounting instruction shrink packed

HBS jeu complet 80026 pour portes pliantes à lamelles à deux vantaux

Longueur du rail 0,80 m;
hauteur de porte 2 m maxi.

Garniture complète avec visserie et instruction de montage sous sachet sous vide.



HBS-Komplett-Bausatz 80027 für zweiflügelige Lamellen-Faltdüren

Schienenlänge 1,20 m;
Türhöhe bis 2 m.

Komplett incl. Befestigungsmaterial und Montageanleitung in Kunststoffhülle eingeschumpft.

HBS complete set 80027 for 2-leaf folding louver doors

Length of track 1,20 m;
Height of door up to 2 m.

Complete set incl. fixing screws and mounting instruction shrink packed

HBS jeu complet 80027 pour portes pliantes à lamelles à deux vantaux

Longueur du rail 1,20 m;
hauteur de porte 2 m maxi.

Garniture complète avec visserie et instruction de montage sous sachet sous vide.



HBS-Zusatzsortiment Aluminium-Laufschiene, gelocht

Schienenlänge 1,50 m

HBS extra set Aluminium track, pre-drilled

Length of track 1,50 m

HBS jeu complémentaire: Rail aluminium, perforé

Longueur du rail 1,50 m



HBS-Zusatzsortiment Aluminium-Laufschiene, gelocht

Schienenlänge 2,00 m

HBS extra set Aluminium track, pre-drilled





















Length of track 2,00 m

HBS jeu complémentaire: Rail aluminium, perforé

Longueur du rail 2,00 m



**Complete sets and extra sets,
the ideal hardware for folding louver doors up to 2 m height**
**Jeux complets et jeux complémentaires,
la ferrure idéale pour portes pliantes à lamelles, hauteur 2 m**

		Inhalt Part Contenu	Stück No. incl. Qté.	Art.-Nr. Art.-No. Art.-No.	Beschreibung Description Description							
<table border="1"> <tr> <td>Art.-Nr. Art.-No. Art.-No.</td> <td>80026</td> </tr> <tr> <td>EAN-Nr.</td> <td>4001425 800264</td> </tr> <tr> <td>Gewicht/Garnitur Weight Poids</td> <td>0,53 kg</td> </tr> </table>	Art.-Nr. Art.-No. Art.-No.	80026	EAN-Nr.	4001425 800264	Gewicht/Garnitur Weight Poids	0,53 kg		1	82063	Aluminium-Laufschiene Länge 0,80 m	Aluminium track, length 0,80 m	Rail aluminium, longueur 0,80 m
	Art.-Nr. Art.-No. Art.-No.	80026										
	EAN-Nr.	4001425 800264										
	Gewicht/Garnitur Weight Poids	0,53 kg										
		1	81340	Endstück	End stop	Sabot						
		1	81343	Gleitstück	Slider	Patin						
		2	81342	Teleskoplager	Retractable upper pivots	Pivots hauts escamotables						
		1	81337	Bodenlager	Bottom pivot	Pivot bas						
	1	81338	Bodenplatte	Bottom plate	Crapaudine							
	1	81336	Mittel-Schließblech	Door aligner	Doigt d'alignement							
	3	81227	Scharniere	Hinges	Charnières							
		1	19420	Einschlagkappe	safety device tool	outil de pose						
<table border="1"> <tr> <td>Art.-Nr. Art.-No. Art.-No.</td> <td>80027</td> </tr> <tr> <td>EAN-Nr.</td> <td>4001425 800271</td> </tr> <tr> <td>Gewicht/Garnitur Weight Poids</td> <td>0,61 kg</td> </tr> </table>	Art.-Nr. Art.-No. Art.-No.	80027	EAN-Nr.	4001425 800271	Gewicht/Garnitur Weight Poids	0,61 kg		1	82068	Aluminium-Laufschiene Länge 1,20 m	Aluminium track, length 1,20 m	Rail aluminium, longueur 1,20 m
	Art.-Nr. Art.-No. Art.-No.	80027										
	EAN-Nr.	4001425 800271										
	Gewicht/Garnitur Weight Poids	0,61 kg										
		1	81340	Endstück	End stop	Sabot						
		1	81343	Gleitstück	Slider	Patin						
		2	81342	Teleskoplager	Retractable upper pivots	Pivots hauts escamotables						
		1	81337	Bodenlager	Bottom pivot	Pivot bas						
	1	81338	Bodenplatte	Bottom plate	Crapaudine							
	1	81336	Mittel-Schließblech	Door aligner	Doigt d'alignement							
	3	81227	Scharniere	Hinges	Charnières							
		1	19420	Einschlagkappe	safety device tool	outil de pose						
<table border="1"> <tr> <td>Art.-Nr. Art.-No. Art.-No.</td> <td>82066</td> </tr> <tr> <td>EAN-Nr.</td> <td>4001425 820668</td> </tr> <tr> <td>Gewicht/Garnitur Weight Poids</td> <td>0,36 kg</td> </tr> </table>	Art.-Nr. Art.-No. Art.-No.	82066	EAN-Nr.	4001425 820668	Gewicht/Garnitur Weight Poids	0,36 kg		1	82066	Aluminium Laufschiene, 1,50 m	Aluminium track 1,50 m	Rail aluminium, 1,50 m
	Art.-Nr. Art.-No. Art.-No.	82066										
	EAN-Nr.	4001425 820668										
Gewicht/Garnitur Weight Poids	0,36 kg											
<table border="1"> <tr> <td>Art.-Nr. Art.-No. Art.-No.</td> <td>82067</td> </tr> <tr> <td>EAN-Nr.</td> <td>4001425 820675</td> </tr> <tr> <td>Gewicht/Garnitur Weight Poids</td> <td>0,48 kg</td> </tr> </table>	Art.-Nr. Art.-No. Art.-No.	82067	EAN-Nr.	4001425 820675	Gewicht/Garnitur Weight Poids	0,48 kg		1	82067	Aluminium Laufschiene, 2,00 m	Aluminium track 2,00 m	Rail aluminium, 2,00 m
	Art.-Nr. Art.-No. Art.-No.	82067										
EAN-Nr.	4001425 820675											
Gewicht/Garnitur Weight Poids	0,48 kg											

Komplett-Bausätze und Zusatzsortimente

Der ideale Beschlag für Lamellen-Falttüren bis 2 m Höhe

HBS-Zusatzsortiment 80025 für zweiflügelige Lamellen-Falttüren

Ohne Laufschiene;
Türhöhe bis 2 m.

Komplett incl. Befestigungs-
material im Beutel
eingeschweißt.

HBS extra set 80025 for 2-leaf folding louver doors

Without track;
height of door up to 2 m.

Complete set incl. fixing
screws in plastic bag.

HBS jeu complémentaire 80025 pour portes pliantes à lamelles à deux vantaux

Sans rail;
hauteur de porte 2 m maxi.

Garniture complète avec
visserie sous sachet plastique.

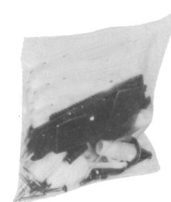

HBS-Zusatzsortiment 81420 2 Scharniere für 1 Tür

Incl. Befestigungsmaterial.

HBS extra set 81420 containing: 2 hinges for 1 door

Incl. fixing screws.

HBS jeu complémen- taire 81420: 2 charnières pour 1 porte

Avec visserie.



HBS-Zusatzsortiment Stangen-Türschloß mit Zylinder und 2 Schlüsseln

Stahlteile verzinkt.

Standard-Stangenlänge
1,20 m; Hub 18 mm.

HBS extra set Cam door lock with cylinder and two keys

Steel parts galvanized.

Standard bar length 1,20 m;
travel 18 mm.



HBS jeu complémentaire: Serrure à pènes avec cylindre et deux clés

Les pièces en acier sont galvanisées.

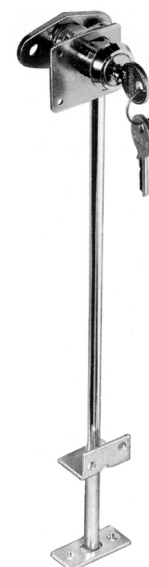
Longueur de pène standard:
1,20 m; course: 18 mm.

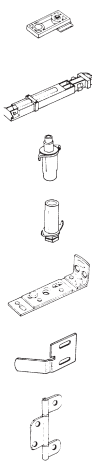

**Complete sets and extra sets,
the ideal hardware for folding louver doors up to 2 m height
Jeux complets et jeux complémentaires,
la ferrure idéale pour portes pliantes à lamelles, hauteur 2 m**

		Inhalt Part Contenu	Stück No. incl. Qté.	Art.-Nr. Art.-No. Art.-No.	Beschreibung Description Description								
<table border="1"> <tr> <td>Art.-Nr. Art.-No. Art.-No.</td> <td>80025</td> </tr> <tr> <td>EAN-Nr.</td> <td>4001425 800257</td> </tr> <tr> <td>Gewicht/Garnitur Weight Poids</td> <td>0,32 kg</td> </tr> </table>		Art.-Nr. Art.-No. Art.-No.	80025	EAN-Nr.	4001425 800257	Gewicht/Garnitur Weight Poids	0,32 kg		<p>1</p> <p>1</p> <p>2</p> <p>1</p> <p>1</p> <p>1</p> <p>3</p> <p>1</p>	<p>81340</p> <p>81343</p> <p>81342</p> <p>81337</p> <p>81338</p> <p>81336</p> <p>81227</p> <p>19420</p>	<p>Endstück</p> <p>Gleitstück</p> <p>Teleskoplager</p> <p>Bodenlager</p> <p>Bodenplatte</p> <p>Mittel-Schließblech</p> <p>Scharniere</p> <p>Einschlagkappe</p>	<p>End stop</p> <p>Slider</p> <p>Retractable upper pivots</p> <p>Bottom pivot</p> <p>Bottom plate</p> <p>Door aligner</p> <p>Hinges</p> <p>safety device tool</p>	<p>Sabot</p> <p>Patin</p> <p>Pivots hauts escamotables</p> <p>Pivot bas</p> <p>Crapaudine</p> <p>Doigt d'alignement</p> <p>Charnières</p> <p>outil de pose</p>
Art.-Nr. Art.-No. Art.-No.	80025												
EAN-Nr.	4001425 800257												
Gewicht/Garnitur Weight Poids	0,32 kg												
<table border="1"> <tr> <td>Art.-Nr. Art.-No. Art.-No.</td> <td>81420</td> </tr> <tr> <td>EAN-Nr.</td> <td>4001425 814209</td> </tr> <tr> <td>Gewicht/Garnitur Weight Poids</td> <td>0,08 kg</td> </tr> </table>		Art.-Nr. Art.-No. Art.-No.	81420	EAN-Nr.	4001425 814209	Gewicht/Garnitur Weight Poids	0,08 kg		<p>2</p>	<p>81227</p>	<p>Scharniere</p>	<p>Hinges</p>	<p>Charnières</p>
Art.-Nr. Art.-No. Art.-No.	81420												
EAN-Nr.	4001425 814209												
Gewicht/Garnitur Weight Poids	0,08 kg												
<table border="1"> <tr> <td>Art.-Nr. Art.-No. Art.-No.</td> <td>81122</td> </tr> <tr> <td>EAN-Nr.</td> <td>4001425 811222</td> </tr> <tr> <td>Gewicht/Garnitur Weight Poids</td> <td>0,66 kg</td> </tr> </table>		Art.-Nr. Art.-No. Art.-No.	81122	EAN-Nr.	4001425 811222	Gewicht/Garnitur Weight Poids	0,66 kg		<p>1</p>	<p>81122</p>	<p>Stangen-Türschloß</p>	<p>Cam door lock</p>	<p>Serrure à pànes</p>
Art.-Nr. Art.-No. Art.-No.	81122												
EAN-Nr.	4001425 811222												
Gewicht/Garnitur Weight Poids	0,66 kg												

Komplett-Bausätze und Zusatzsortimente

Der ideale Beschlag für Lamellen-Falttüren über 2 m Höhe

HBS-Komplett-Bausatz 80029 für zweiflügelige Lamellen-Falttüren

Schienenlänge 1,10 m;
Türhöhe übe 2 m.

Komplett incl. Befestigungs-
material und Montage-
anleitung in Kunststoffhülle
eingeschumpft.

HBS complete set 80029 for 2-leaf folding louver doors

Length of track 1,10 m;
Height of door over 2 m.

Complete set incl. fixing
screws and mounting
instruction shrink packed

HBS jeu complet 80029 pour portes pliantes à lamelles à deux vantaux

Longueur du rail 1,10 m;
hauteur de porte au-delà 2 m.

Garniture complète avec
visserie et instruction de
montage sous sachet sous
vide.



HBS-Zusatzsortiment 80028 für zweiflügelige Lamellen-Falttüren

Ohne Laufschiene;
Türhöhe über 2 m.

Komplett incl. Befestigungs-
material im Beutel
eingeschweißßt.

HBS extra set 80028 for 2-leaf folding louver doors

Withoaut track;
height of door over 2 m.

Complete set incl. fixing
screws in plastic bag.

HBS jeu complet 80028 pour portes pliantes à lamelles à deux vantaux

Sans rail;
hauteur de porte au-delà 2 m.

Garniture complète avec
visserie sous sachet plastique.

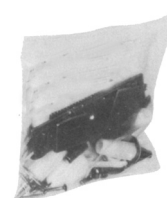

HBS-Zusatzsortiment 81420 2 Scharniere für 1 Tür

Incl. Befestigungsmaterial.

HBS extra set 81420 containing: 2 hinges for 1 door

Incl. fixing screws.

HBS jeu complémen- taire 81420: 2 charnières pour 1 porte

Avec visserie.



HBS-Zusatzsortiment Aluminium-Laufschiene, gelocht

Schienenlänge 1,50 m

HBS extra set Aluminium track, pre-drilled

Length of track 1,50 m

HBS jeu complémentaire: Rail aluminium, perforé

Longueur du rail 1,50 m



HBS-Zusatzsortiment Aluminium-Laufschiene, gelocht

Schienenlänge 2,00 m

HBS extra set Aluminium track, pre-drilled



















Length of track 2,00 m

HBS jeu complémentaire: Rail aluminium, perforé

Longueur du rail 2,00 m



**Complete sets and extra sets,
the ideal hardware for folding louver doors over 2 m height
Jeux complets et jeux complémentaires,
la ferrure idéale pour portes pliantes à lamelles, hauteur au-delà 2 m**

		Inhalt Part Contenu	Stück No. incl. Qté.	Art.-Nr. Art.-No. Art.-No.	Beschreibung Description Description								
<table border="1"> <tr> <td>Art.-Nr. Art.-No. Art.-No.</td> <td>80029</td> </tr> <tr> <td>EAN-Nr.</td> <td>4001425 800295</td> </tr> <tr> <td>Gewicht/Garnitur Weight Poids</td> <td>0,88 kg</td> </tr> </table>		Art.-Nr. Art.-No. Art.-No.	80029	EAN-Nr.	4001425 800295	Gewicht/Garnitur Weight Poids	0,88 kg	       	2 1 1 3 1 1 1 3	82065 81340 81343 81342 81337 81339 81341 81227	Aluminium-Laufschienen, Länge 1,10 m Endstück Gleitstück Teleskoplager Bodenlager Bodengegenlager unteres Gleitstück Scharniere	Aluminium tracks, length 1,10 m End stop Slider Retractable upper pivot Bottom pivot Bottom pivot base Bottom slider Hinges	Rails aluminium, longueur 1,10 m Sabot Patin Pivot haut escamotable Pivot bas Crapaudine Galet Charnières
Art.-Nr. Art.-No. Art.-No.	80029												
EAN-Nr.	4001425 800295												
Gewicht/Garnitur Weight Poids	0,88 kg												
<table border="1"> <tr> <td>Art.-Nr. Art.-No. Art.-No.</td> <td>80028</td> </tr> <tr> <td>EAN-Nr.</td> <td>4001425 800288</td> </tr> <tr> <td>Gewicht/Garnitur Weight Poids</td> <td>0,25 kg</td> </tr> </table>		Art.-Nr. Art.-No. Art.-No.	80028	EAN-Nr.	4001425 800288	Gewicht/Garnitur Weight Poids	0,25 kg	      	1 1 3 1 1 1 3	81340 81343 81342 81337 81339 81341 81227	Endstück Gleitstück Teleskoplager Bodenlager Bodengegenlager unteres Gleitstück Scharniere	End stop Slider Retractable upper pivot Bottom pivot Bottom pivot base Bottom slider Hinges	Sabot Patin Pivot haut escamotable Pivot bas Crapaudine Galet Charnières
Art.-Nr. Art.-No. Art.-No.	80028												
EAN-Nr.	4001425 800288												
Gewicht/Garnitur Weight Poids	0,25 kg												
<table border="1"> <tr> <td>Art.-Nr. Art.-No. Art.-No.</td> <td>81420</td> </tr> <tr> <td>EAN-Nr.</td> <td>4001425 814209</td> </tr> <tr> <td>Gewicht/Garnitur Weight Poids</td> <td>0,08 kg</td> </tr> </table>		Art.-Nr. Art.-No. Art.-No.	81420	EAN-Nr.	4001425 814209	Gewicht/Garnitur Weight Poids	0,08 kg		2	81227	Scharniere	Hinges	Charnières
Art.-Nr. Art.-No. Art.-No.	81420												
EAN-Nr.	4001425 814209												
Gewicht/Garnitur Weight Poids	0,08 kg												
<table border="1"> <tr> <td>Art.-Nr. Art.-No. Art.-No.</td> <td>82066</td> </tr> <tr> <td>EAN-Nr.</td> <td>4001425 820668</td> </tr> <tr> <td>Gewicht/Garnitur Weight Poids</td> <td>0,36 kg</td> </tr> </table>		Art.-Nr. Art.-No. Art.-No.	82066	EAN-Nr.	4001425 820668	Gewicht/Garnitur Weight Poids	0,36 kg		1	82066	Aluminium Laufschiene, 1,50 m	Track, Aluminium, 1,50 m	Rail Aluminium, 1,50 m
Art.-Nr. Art.-No. Art.-No.	82066												
EAN-Nr.	4001425 820668												
Gewicht/Garnitur Weight Poids	0,36 kg												
<table border="1"> <tr> <td>Art.-Nr. Art.-No. Art.-No.</td> <td>82067</td> </tr> <tr> <td>EAN-Nr.</td> <td>4001425 820675</td> </tr> <tr> <td>Gewicht/Garnitur Weight Poids</td> <td>0,48 kg</td> </tr> </table>		Art.-Nr. Art.-No. Art.-No.	82067	EAN-Nr.	4001425 820675	Gewicht/Garnitur Weight Poids	0,48 kg		1	82067	Aluminium Laufschiene, 2,00 m	Track, Aluminium, 2,00 m	Rail Aluminium, 2,00 m
Art.-Nr. Art.-No. Art.-No.	82067												
EAN-Nr.	4001425 820675												
Gewicht/Garnitur Weight Poids	0,48 kg												

Pendeltürbeschlag

für 19 - 44 mm starke Lamellentüren

Gravity hinges for swinging doors

for louver doors from 19 to 44 mm thickness

Charnières de gravité pour portes va-et-vient

pour portes à lamelles de 19 à 44 mm d'épaisseur

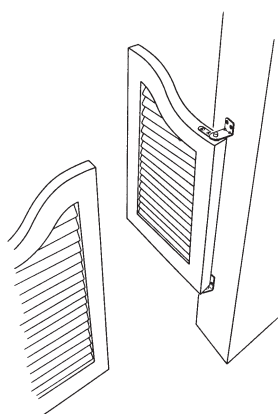

HBS-Garnitur Pendeltürbeschläge für 2 Saloontürflügel

Alle Türlager aus Stahl, gelb verzinkt; untere Türlager zusätzlich mit Kunststoffheber.

Einfache Konstruktion; Türen im Öffnungswinkel von 90° feststellbar, dabei ca. 10 mm Hub.

Komplett incl. Holzschrauben und Montageanleitung in Kunststoffhülle eingeschumpft.

HBS complete set Gravity hinge sets for 2 louver doors

Guide hinges made of steel, yellow galvanized; raising bottom bearing with polyamide parts.

Simple construction; automatic hold-open at 90°; doors raise during opening range by 10 mm.

Complete set incl. screws and mounting instruction shrink packed.

HBS jeu complet Charnières de gravité pour portes de gravité pour portes va-et-vient pour 2 vantaux

Pivots en acier, galvanisés jaune, pivots bas avec élévateur en polyamide.

Construction simple; arrêt automatique des portes à 90°, levée d'environ 10 mm.

Garniture complète avec visserie et instruction de montage sous sachet sous vide.



		Inhalt Part Contenu	Stück No. incl. Qté.	Beschreibung Description Description								
<table border="1"> <tr> <td>Art.-Nr. Art.-No. Art.-No.</td> <td>80030</td> </tr> <tr> <td>EAN-Nr.</td> <td>4001425 800301</td> </tr> <tr> <td>Gewicht/Garnitur Weight Poids</td> <td>0,25 kg</td> </tr> </table>		Art.-Nr. Art.-No. Art.-No.	80030	EAN-Nr.	4001425 800301	Gewicht/Garnitur Weight Poids	0,25 kg		2	oberes Türlager	top bearing	pivot haut
Art.-Nr. Art.-No. Art.-No.	80030											
EAN-Nr.	4001425 800301											
Gewicht/Garnitur Weight Poids	0,25 kg											
			2	unteres Türlager	bottom bearing	pivot bas						

Komplett-Bausätze für Schiebe- und Falttür-Beschläge in SB-Präsentation

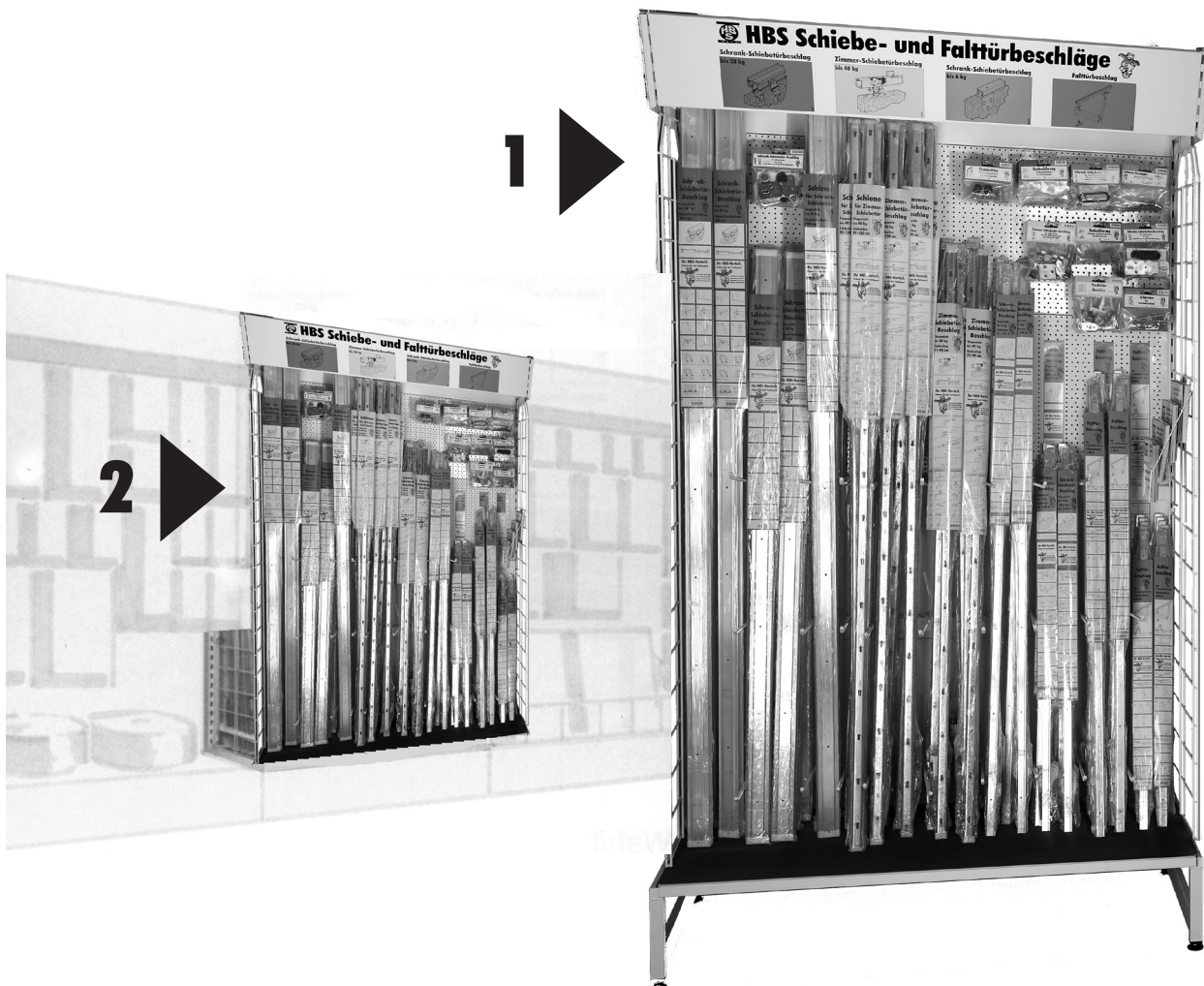

So oder so - Sie haben die Wahl



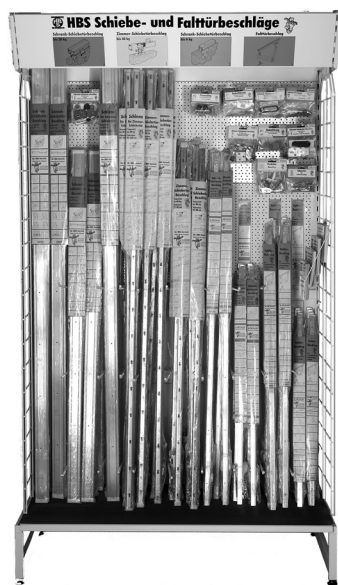

1 Freistehend: Beliebig platzierbar und flexibel durch zwei unterschiedlich breite Ausführungen (1030 und 1280 mm), mit dem freistehenden SB-Ständer von HBS positionieren Sie ihre Komplettbausätze für Schiebetürbeschläge immer dort, wo Sie es gerade möchten.

2 Oder integriert: Die SB-Elemente von HBS lassen sich auch in alle handelsüblichen Regalsysteme mit gelochter Rückwand integrieren, in den gängigen Rastermaßen 1000 mm und 1250 mm.

Erst-Bestückung: Am besten komplett SB-Element 89026 und 89027 - freistehend







Unser Vorschlag für die Erstbestückung. Bei einer Komplett-Bestückung, wie nebenstehend aufgeführt, wird Ihnen der SB-Ständer ohne Kosten leihweise zur Verfügung gestellt. Sie bieten Ihren Kunden größtmögliche Auswahl.

Komplett-Bausätze, eingeschumpft	Art.-Nr.	EAN-Nr.	Schiene- länge in cm	max. Tür- gewicht in kg	Verp.- Einheit
 <p>Schrank-Schiebetür-Beschlag für 2 Türen</p>	80012 80013	4 001425 800127 4 001425 800134	150 200	28 28	10 10
 <p>Zimmer-Schiebetür-Beschlag für 1 Tür</p>	80003 80004	4 001425 800035 4 001425 800042	155 185	40 40	10 10
 <p>Gleitbeschlag für 2 leichte Schrank- Schiebetüren</p>	80009 80010	4 001425 800097 4 001425 800103	100 150	6 6	10 10
 <p>Falttürbeschlag für 2 Türflügel Türhöhe max. 2 m</p>	80026 80027	4 001425 800264 4 001425 800271	80 120	– –	10 10
 <p>Pendeltür- Beschlag</p>	80030	4 001425 800301	–	–	10

Zusatz-Sortimente in Beutelverpackung		Art.-Nr.	EAN-Nr.	Verp.- Einheit
	1 Schrank-Schiebetürbeschlag zu 80012, 80013 für 1 zusätzliche Tür (2 Einzel-Rollapparate + 1 Bodenführung)	81414	4 001425 814148	10
	2 Türstopper zu 80012 und 80013	81417	4 001425 814179	6
	2 Bodenführungen zu 80012, 80013, 80009, 80010	81419	4 001425 814193	10
	2 Bodenführungen zu 80012, 80013, 80003, 80004	81418	4 001425 814186	10
	1 Zimmer-Schiebetürbeschlag zu 80003 und 80004 für 1 zusätzliche Tür (2 Laufwagen, 4 Befestigungsplatten, 2 Schienen-Türstopper + 1 Bodenführung)	80031	4 001425 800318	5
	1 Schrank-Schiebetürbeschlag zu 80009 und 80010 für 1 zusätzliche Tür (2 Gleiter, 1 Muschelgriff + 1 Bodenführung)	80032	4 001425 800325	10
	3 Schienen-Türstopper zu 80009 und 80010	81416	4 001425 814162	10
	2 Scharniere zu 80026 und 80027	81420	4 001425 814209	10
	Montageanleitungen DIN A 5 quer: Schrank-Schiebetürbeschlag Zimmer-Schiebetürbeschlag leichter Schrank-Schiebetürbeschlag Fallt-Türbeschlag	89044 89043 89046 89045	4 001425 890449 4 001425 890432 4 001425 890463 4 001425 890456	40 40 40 40

Erst-Bestückung: Am besten komplett SB-Element 89024 und 89025 - integriert

Komplett-Bausätze, eingeschrumpft		Art.-Nr.	EAN- Nr.	Schiene- länge in cm	max. Tür- gewicht in kg	Verp.- Einheit
	Schrank-Schiebetür- beschlag für 2 Türen	80012	4 001425 800127	150	28	10
		80013	4 001425 800134	200	28	10
	Zimmer-Schiebetür- beschlag für 1 Tür	80003	4 001425 800035	155	40	10
		80004	4 001425 800042	185	40	10
	Gleitbeschlag für 2 leichte Schrank- Schiebetüren	80009	4 001425 800097	100	6	10
		80010	4 001425 800103	150	6	10
	Falttürbeschlag für 2 Türflügel Türhöhe max. 2 m	80026	4 001425 800264	80	–	10
		80027	4 001425 800271	120	–	10
	Pendeltürbeschlag für 2 Salootürflügel	80030	4 001425 800301	–	–	10



Auch hier lohnt sich die Komplett-Bestückung: Das Halterungs-Set wird dann ohne Kosten leihweise zur Verfügung gestellt. Achtung: Für das integrierte SB-Element benötigen Sie eine gelochte Rückwand!

Zusatz-Sortimente in Beutelverpackung		Art.-Nr.	EAN-Nr.	Verp.- Einheit
	1 Schrank-Schiebetürbeschlag zu 80012, 80013 für 1 zusätzliche Tür (2 Einzel-Rollapparate + 1 Bodenführung)	81414	4 001425 814148	10
	2 Türstopper zu 80012 und 80013	81417	4 001425 814179	6
	2 Bodenführungen zu 80012, 80013, 80009, 80010	81419	4 001425 814193	10
	2 Bodenführungen zu 80012, 80013, 80003, 80004	81418	4 001425 814186	10
	1 Zimmer-Schiebetürbeschlag zu 80003 und 80004 für 1 zusätzliche Tür (2 Laufwagen, 4 Befestigungsplatten, 2 Schienen-Türstopper + 1 Bodenführung)	80031	4 001425 800318	5
	1 Schrank-Schiebetürbeschlag zu 80009 und 80010 für 1 zusätzliche Tür (2 Gleiter, 1 Muschelgriff + 1 Bodenführung)	80032	4 001425 800325	10
	3 Schienen-Türstopper zu 80009 und 80010	81416	4 001425 814162	10
	2 Scharniere zu 80026 und 80027	81420	4 001425 814209	10
	Montageanleitungen DIN A 5 quer: Schrank-Schiebetürbeschlag Zimmer-Schiebetürbeschlag leichter Schrank-Schiebetürbeschlag Fall-Türbeschlag	89044 89043 89046 89045	4 001425 890449 4 001425 890432 4 001425 890463 4 001425 890456	40 40 40 40

Die Ausführungen: freistehend oder integriert

freistehend

schmal

Art.-Nr. 89026

EAN-Nr. 4 001425 890265
 Schmale Ausführung:
 Höhe: 2270 mm
 Breite: 1030 mm
 Tiefe: 650 mm
 Gewicht ohne
 Bestückung: 103,0 kg
 Gewicht mit
 Bestückung: 197,1 kg
 Farbe: neutralweiß

breit

Art.-Nr. 89027

EAN-Nr. 4 001425 890272
 Breite Ausführung:
 Höhe: 2270 mm
 Breite: 1280 mm
 Tiefe: 650 mm
 Gewicht ohne
 Bestückung: 115,0 kg
 Gewicht mit
 Bestückung: 209,1 kg
 Farbe: neutralweiß

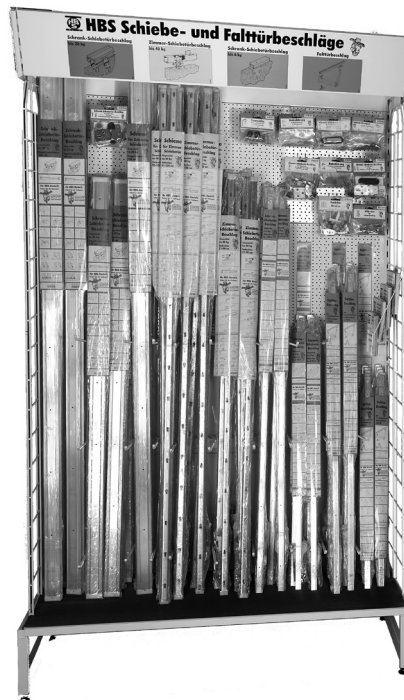

integriert

schmal

Art.-Nr. 89024

EAN-Nr. 4 001425 890241
 Schmale Ausführung:
 Ohne Rückwand und
 Fußgestell, im Rastermaß
 1000 mm.
 Für das integrierte SB-Element
 benötigen Sie eine gelochte Rück-
 wand!
 Höhe mind.: 2025 mm
 Regaltiefe mind.: 650 mm
 Gewicht ohne
 Bestückung: 63,0 kg
 Gewicht mit
 Bestückung: 157,1 kg
 Farbe: neutralweiß

breit

Art.-Nr. 89025

EAN-Nr. 4 001425 890258
 Breite Ausführung:
 Ohne Rückwand und
 Fußgestell, im Rastermaß
 1250 mm.
 Für das integrierte SB-Element
 benötigen Sie eine gelochte
 Rückwand!
 Höhe mind.: 2025 mm
 Regaltiefe mind.: 650 mm
 Gewicht ohne
 Bestückung: 68,0 kg
 Gewicht mit
 Bestückung: 162,1 kg
 Farbe: neutralweiß

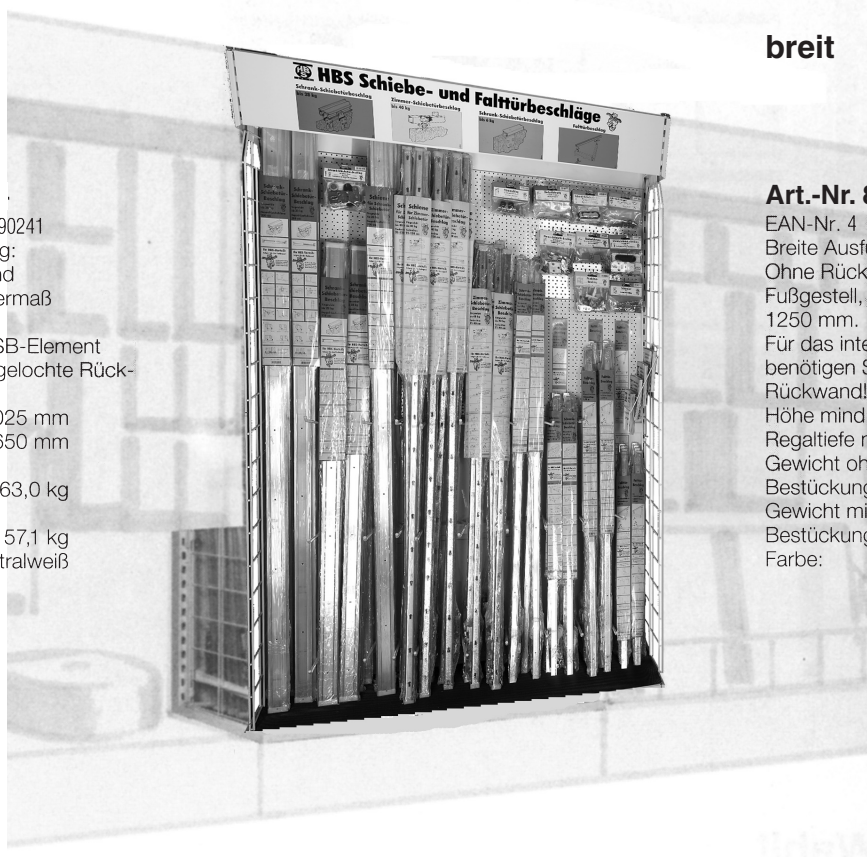

Schiebetür-Röhrenlaufwerke in SB-Präsentation

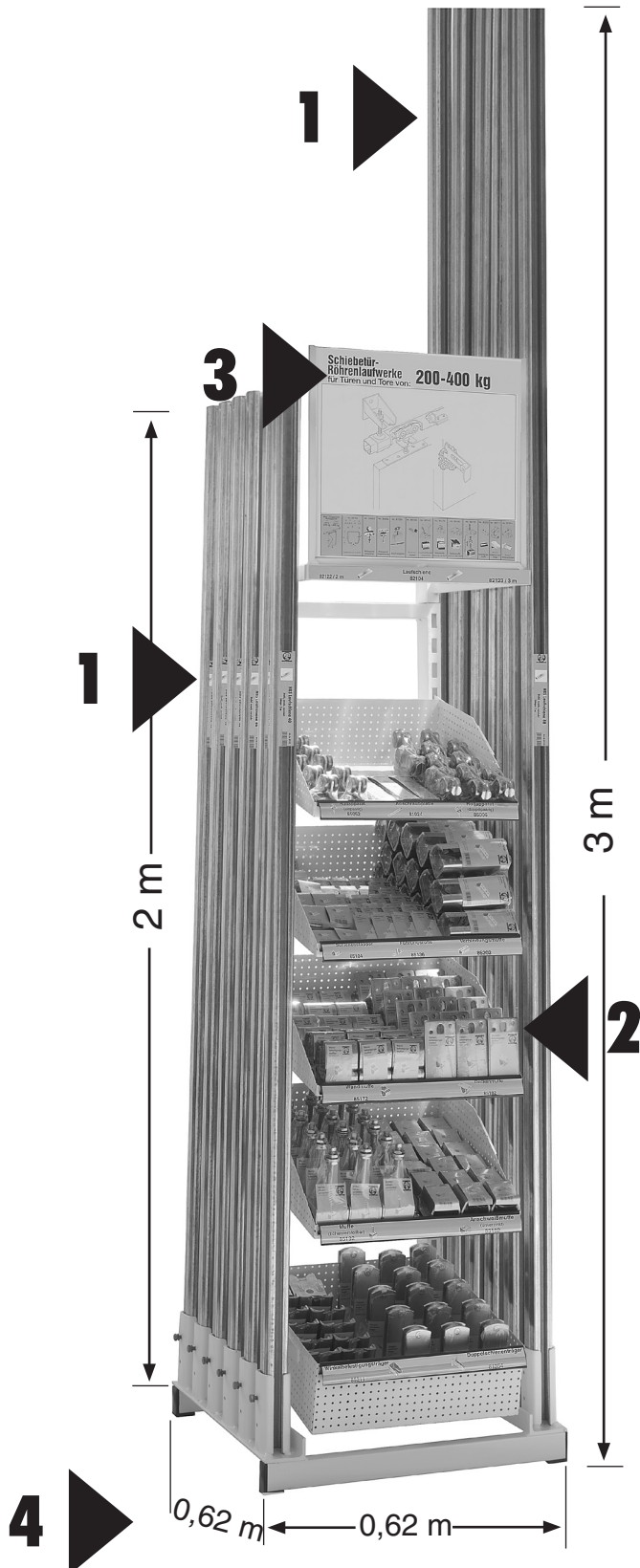

**Handlich. Verkaufsfördernd.
Mit allem Drum und Dran.**

1 Flexibel mit fixen Schienenlängen: Mit den Standardlängen der Laufschiene von 2 m und 3 m lassen sich die Zuschnitte für jede beliebige Torbreite kombinieren. Personalintensives Ablängen entfällt. Und die handlichen Längen lassen sich von Ihren Kunden problemlos transportieren.

2 Mit Selbstbedienung und Farbleitsystem voll im Trend: der Kunde findet alle Teile im SB-Ständer übersichtlich angeordnet und farblich gekennzeichnet. Kein Warten auf Bedienung mehr, optimal für alle, die es eilig haben.

3 Verkaufsberatung mit dabei: Auf einem Display am Kopf des Ständers findet der Käufer Informationen über Anwendungsbereiche und die notwendigen Montageteile. Lästiges Nachfragen entfällt; das Sortiment verkauft sich ganz von selbst und Ihre Mitarbeiter werden nicht zusätzlich belastet.

4 Alles auf 0,38 Quadratmeter: Kundenfreundliche Warenpräsentation mit minimaler Stellfläche. Der SB-Verkaufsstand findet mit einer Grundfläche von 62 cm x 62 cm überall Platz und sorgt für einen lukrativen Umsatz pro qm.





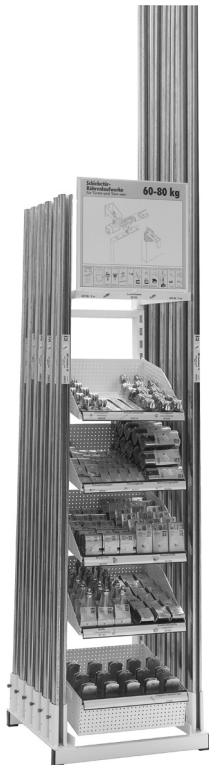







Erst-Bestückung, die sich rechnet

für Torgewichte
bis 80 kg

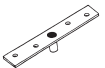

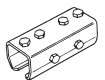
SB-Ständer
Art.-Nr. 89057

Am besten komplett:
Den HBS-Verkaufsständer gibt es in zwei Ausstattungen, je nach Gewicht der Türen und Tore. So könnte die Erstbestückung für **Tore bis 80 kg** aussehen. Das vollständige Sortiment der Montage-Teile sorgt für zufriedene Kunden und wer zufrieden ist, kommt wieder. Und bei einer Komplett-Bestückung wird Ihnen der SB-Ständer ohne Kosten leihweise zur Verfügung gestellt.

	Bezeichnung	Art.-Nr.	EAN-Nr.	Menge
	Laufschiene, 2 m lang	82138	4001425821382	6
	Laufschiene, 3 m lang	82136	4001425821368	6
	Rollapparate, einpaarig	85050	4001425850504	10
	Schiene-Türstopper	85101	4001425851013	20
	Wandbefestigungsmuffen	85170	4001425851709	20
	Muffen, höhenverstellbar	85190	4001425851907	20
	Anschraubplatten	81014	4001425810140	20
	Führungsrollen	81171	4001425811710	20
	Rollapparate, doppelpaarig	85000	4001425850009	10
	Verbindungsmuffen	85200	4001425852003	20
	Deckenbefestigungsmuffen	85180	4001425851808	20
	Anschweißmuffen, unverzinkt	85160	4001425851600	20
	Doppelschienträger	81301	4001425813011	15





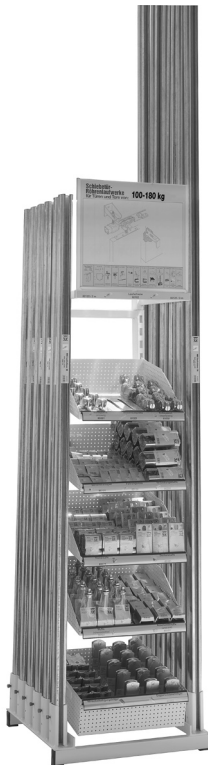







Erst-Bestückung, die sich rechnet

für Torgewichte
bis 180 kg

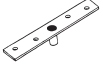

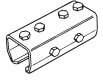
**SB-Ständer
Art.-Nr. 89058**

Am besten komplett:
Den HBS-Verkaufsständer
gibt es in zwei Ausstattungen,
je nach Gewicht der Türen
und Tore. So könnte die Erst-
bestückung für Tore bis 180 kg
aussehen. Das vollständige
Sortiment der Montage-Teile
sorgt für zufriedene Kunden
und wer zufrieden ist, kommt
wieder. Und bei einer Komplett-
Bestückung wird Ihnen der SB-
Ständer ohne Kosten leihweise
zur Verfügung gestellt.

	Bezeichnung	Art.-Nr.	EAN-Nr.	Menge
	Laufschiene, 2 m lang	82120	4001425821207	6
	Laufschiene, 3 m lang	82121	4001425821214	6
	Rollapparate, einpaarig	85051	4001425850511	10
	Schiene-Türstopper	85101	4001425851013	20
	Wandbefestigungsmuffen	85171	4001425851716	20
	Muffen, höhenverstellbar	85191	4001425851914	20
	Winkelbefestigungen	85211	4001425852119	15
	Anschraubplatten	81021	4001425810218	20
	Führungsrollen	85136	4001425851365	20
	Rollapparate, doppelpaarig	85002	4001425850023	10
	Verbindungsmuffen	85201	4001425852010	20
	Deckenbefestigungsmuffen	85181	4001425851815	20
	Anschweißmuffen, unverzinkt	85161	4001425851617	20
	Doppelschienträger	81354	4001425813547	15











Erst-Bestückung, die sich rechnet

für Torgewichte
bis 400 kg

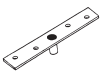

SB-Ständer
Art.-Nr. 89059

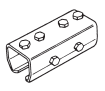
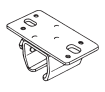
Am besten komplett:
Den HBS-Verkaufsständer
gibt es in zwei Ausstattungen,
je nach Gewicht der Türen
und Tore. So könnte die Erst-
bestückung für **Tore bis 400 kg**
aussehen. Das vollständige
Sortiment der Montage-Teile
sorgt für zufriedene Kunden
und wer zufrieden ist, kommt
wieder. Und bei einer Komplett-
Bestückung wird Ihnen der SB-
Ständer ohne Kosten leihweise
zur Verfügung gestellt.

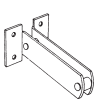
	Bezeichnung	Art.-Nr.	EAN-Nr.	Menge
	Laufschiene, 2 m lang	82122	4001425821221	6
	Laufschiene, 3 m lang	82123	4001425821238	6
	Rollapparate, einpaarig	85052	4001425850528	10
	Schiene-Türstopper	85104	4001425851044	20
	Wandbefestigungsmuffen	85172	4001425851723	20
	Muffen, höhenverstellbar	85192	4001425851921	20
	Winkelbefestigungen	85211	4001425852119	15
	Anschraubplatten	81024	4001425810249	20
	Führungsrollen	85136	4001425851365	20
	Rollapparate, doppelpaarig	85006	4001425850061	10
	Verbindungsmuffen	85202	4001425852027	20
	Deckenbefestigungsmuffen	85182	4001425851822	20
	Anschweißmuffen, unverzinkt	85162	4001425851624	20
	Doppelschienträger	81354	4001425813547	15





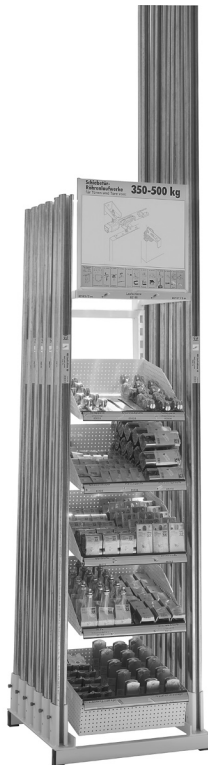





Erst-Bestückung, die sich rechnet

für Torgewichte
bis 500 kg

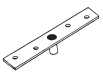

**SB-Ständer
Art.-Nr. 89060**

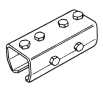
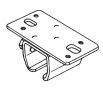
Am besten komplett:
Den HBS-Verkaufsstand
gibt es in zwei Ausstattungen,
je nach Gewicht der Türen
und Tore. So könnte die Erst-
bestückung für Tore bis 500 kg
aussehen. Das vollständige
Sortiment der Montage-Teile
sorgt für zufriedene Kunden
und wer zufrieden ist, kommt
wieder. Und bei einer Komplett-
Bestückung wird Ihnen der SB-
Ständer ohne Kosten leihweise
zur Verfügung gestellt.

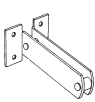
	Bezeichnung	Art.-Nr.	EAN-Nr.	Menge
	Laufschiene, 2 m lang	82163	4001425 821634	5
	Laufschiene, 3 m lang	82137	4001425 821375	5
	Rollapparate, einpaarig	85053	4001425 850535	10
	Schiene-Türstopper	85105	4001425 851051	20
	Wandbefestigungsmuffen	85173	4001425 851730	16
	Muffen, höhenverstellbar	85193	4001425 851938	12
	Winkelbefestigungen	85212	4001425 852126	12
	Anschraubplatten	81028	4001425 810287	20
	Führungsrollen	85130	4001425 851303	20
	Rollapparate, doppelpaarig	85008	4001425 850085	10
	Verbindungsmuffen	85203	4001425 852034	15
	Deckenbefestigungsmuffen	85183	4001425 851839	15
	Anschweißmuffen, unverzinkt	85163	4001425 851631	15
	Doppelschienträger	81379	4001425 813790	12

Ein professionelles System für den professionellen Kunden

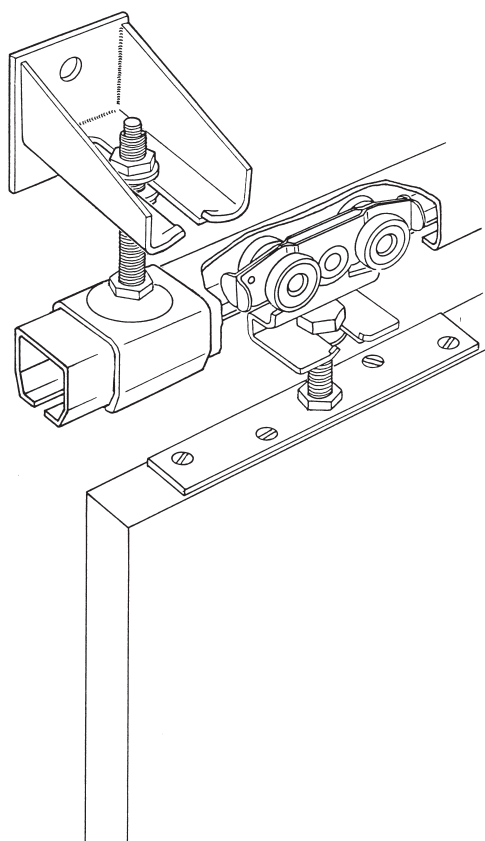

Der SB-Verkaufsstand von HBS für den Profi: Hier findet er alles, was er zur Montage von Schiebetüren und -toren benötigt. In übersichtlicher, kundenfreundlicher Präsentation und auf kleinstem Raum.

Art.-Nr.	EAN-Nr.	Breite	Tiefe	erforderl. Höhe
89057	4001425890579	62 cm	62 cm	3,30 m
89058	4001425890586	62 cm	62 cm	3,30 m
89059	4001425890593	62 cm	62 cm	3,30 m
89060	4001425890609	62 cm	62 cm	3,30 m